



FACTORY CONTACT INFORMATION



BAY TEK GAMES INC.
Pulaski Industrial Park
1077 East. Glenbrook Drive
Pulaski, WI 54162 USA

JOIN OUR SERVICE FIRST NETWORK!

This free service is intended to keep you up to date on the latest game information, early notification of parts specials, pertinent technical bulletins, updates on retro fit parts, software upgrades, and much more.

Log on to: www.baytekgames.com/parts
then click on the Parts N' Service tab, or scan the QR code below with your Smartphone to jump straight to this game's parts page!

Scan here!



SALES

P: 920.822.3951

F: 920.822.8936

E: sales@baytekgames.com

PARTS

P: 920.822.3951 X 1101

F: 920.822.1496

E: parts@baytekgames.com

SERVICE

P: 920.822.3951 X 1102

F: 920.822.1496

E: service@baytekgames.com

MON - FRI
8 AM - 5 PM C.S.T.

All games are proudly manufactured at our factory in Pulaski, Wisconsin, USA

TABLE OF CONTENTS

FACTORY CONTACT INFORMATION	2
WELCOME TO: Super Shot	4
HOW TO PLAY	5
SPECIFICATIONS	6
SAFETY PRECAUTIONS	6
SET UP GUIDE	7-17
HOW TO: INSTALL LINKING KIT	18-20
DIP SWITCH SETTINGS	21
MAIN MENU FUNCTIONS	22
CREDITS PER PLAY	23
ATTRACT VOLUME	23
GAME VOLUME	23
ATTRACT TIMING	24
JOIN IN TIME DELAY	24
GAME LENGTH	24
THREE POINT TIME	25
POINTS NEEDED FOR BONUS TIME	25
BONUS TIME REWARDED	25
BONUS TIME MODE	26
POINTS PER TICKET	26
DOUBLE TICKETS	26
MINIMUM TICKETS DURING GAME PLAY	27
JACKPOT INCREMENT	27
JACKPOT DECREMENT	27
JACKPOT MINIMUM	28
JACKPOT MAXIMUM	28
MINIMUM HIGH SCORE	29
HIGH SCORE RESET	29
RESET SETTINGS	29
DIAGNOSTICS	30
MAIN BOARD WIRING PIN OUT	31
WIRING DIAGRAMS	32-35
TROUBLE SHOOTING GUIDE	36-41
HOW TO GUIDES	42-43
BILL ACCEPTOR DIAGNOSTICS	44
POWER SUPPLY DIAGNOSTICS	45
MAINBOARD PINOUT & GUIDE	46-47
PARTS LIST	48
PARTS PICTURES	49-50
OPTIONAL JACKPOT SIGN	51-54
OPTIONAL GAME DIVIDERS	55-62
OPTIONAL SIDE SKIRTS	63-64
MAINTENANCE LOG	65
TECHNICAL SUPPORT	66
WARRANTY	67

WELCOME TO: Super Shot

Congratulations on your Super Shot purchase!

With its enhanced backboard lighting, easy-to-read time and score displays, along with the excitement of a moving target, Super Shot is the standard in arcade basketball! Link a bank of games together with an attractive jackpot sign to create an incredible presence!

Please take a moment to read through this manual and be sure to contact our factory if you have any questions, or would like some more information.

Thank you for your purchase! Your business is important to us and we hope you enjoy this game as much as we do!

Your Friends at Bay Tek Games



GAME INSPECTION

Inspect the game for any damaged, loose, or missing parts.

If damage is found, please contact your freight carrier first.

Then, contact Bay Tek Games' Service Department at 920.822.3951 or e-mail them at service@baytekgames.com for further assistance.

HOW TO PLAY

Insert credits and select game play:

A - CLASSIC: Basket stays up front until last part of game when it moves to rear

B - CONTINUOUS: Basket moves back and forth throughout game play

C - PUSH BACK: Basket moves in increments after each successful basket

D - STATIONARY: Basket is set to the back wall and does not move



Wait for others to join for competition play.

Shoot as many balls as you can in the allotted time and make them in the hoop to score points!

Win tickets for points scored! Beat the jackpot score and win the jackpot tickets!



GAME SPECIFICATIONS

WEIGHT	
NET WEIGHT	900 LBS.
SHIP WEIGHT	960 LBS.
DIMENSIONS	
WIDTH	34"
DEPTH	126"
HEIGHT	108"
OPERATING TEMPERATURE	
FAHRENHEIT	80-100
CELSIUS	26.7-37.8

POWER REQUIREMENTS			
INPUT VOLTAGE RANGE	100 to 120 VAC	/	220 to 240 VAC
INPUT FREQUENCY RANGE	50 HZ	/	60 HZ

MAX OPERATING CURRENT	
1.4 AMPS @ 115 VAC	
.8 AMPS @ 230 VAC	

SAFETY PRECAUTIONS

NOTICE	
Modifications to the mechanical, electrical and structural components of this game may void its compliance certifications.	
This appliance is suitable for INDOOR, DRY locations only.	
DANGER	
DO NOT perform repairs or maintenance on this game with the power ON. Unplug the unit from the wall outlet or shut off the power strip located inside the cabinet.	
WARNING	
Use of flammable substances can cause sever burns or serious injury. Always use NON-FLAMMABLE solvents for cleaning. DO NOT use gasoline kerosene or thinners.	
CAUTION	
Lifting heavy objects can cause back, neck or other injuries. Be sure adequate lifting and moving devices are available when unloading, unpacking and moving this game.	
ATTENTION	
Be sure the electrical power matches the game requirements. See the serial number located on the back of the game cabinet. Always plug into a grounded circuit. If the supply cord is damaged, it must be replaced by an approved cord or assembly provided by the manufacturer. A shielded power cable must be used for the game to retain EU/EMC compliance.	
IN CASE OF EMERGENCY	
UNPLUG THE POWER CORD. The power cord must be accessible at all times in case of an emergency.	

SET UP GUIDE

Lay the clear backboard on a clean, stable surface.



Locate the hardware kit inside the cash box. Remove four flat washers, two split washers, two nylon nuts and two hex-bolts.



With assistance, lift the backboard piece and insert it into the rear of the ball ramp.

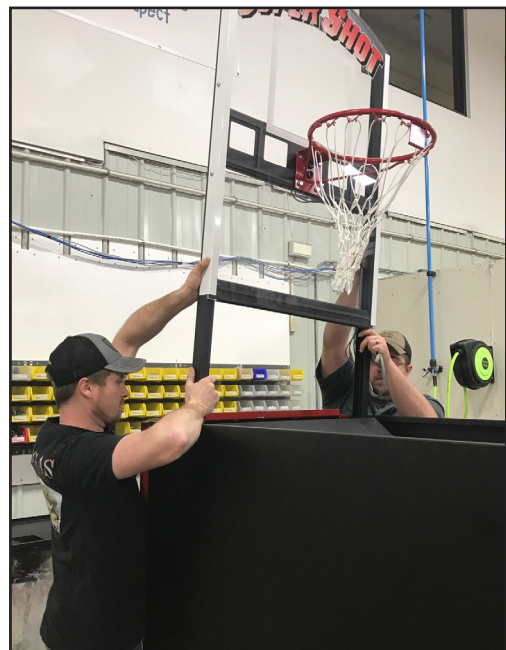

SET UP GUIDE CONT.

The legs of the backboard will slide into the red cut outs and rest on the pemstuds at the bottom.

On the top of the legs, secure to the red metal cut out pieces using a flat washer, a split washer and the hexbolt - one on each side. (highlighted in pink)

On the bottom of the legs, secure to the pemstud using a flat washer and a nylon nut - one on each side. (highlighted in green)

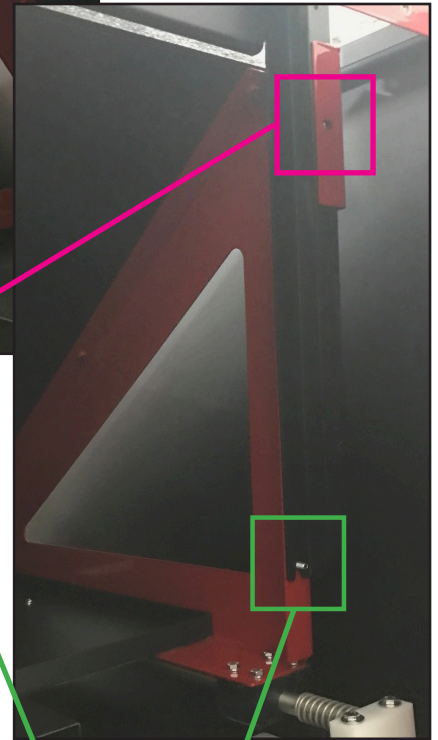
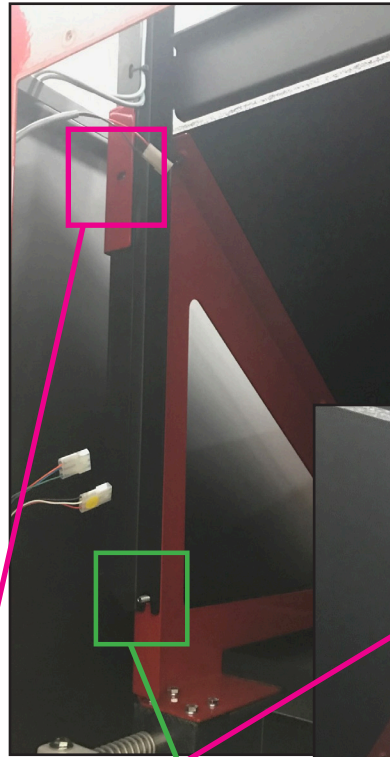

SET UP GUIDE CONT.

Plug in the gray cables from the backboard, to the corresponding colored housings on the gray cables (hoop sensors) already ran on the bottom back of the ramp.

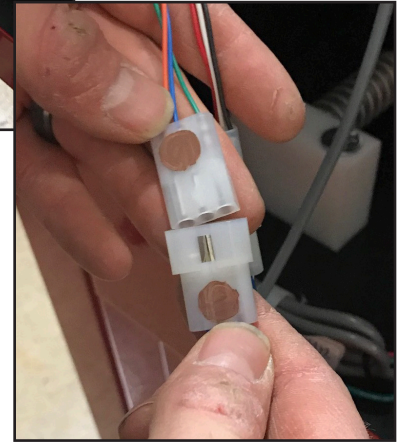
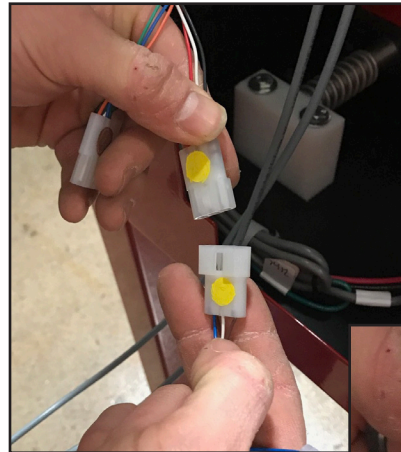

Leaving a service loop of 16"-18", secure the cables to the sticky tabs already attached to the cabinet, using the zip ties included in the hardware kit.

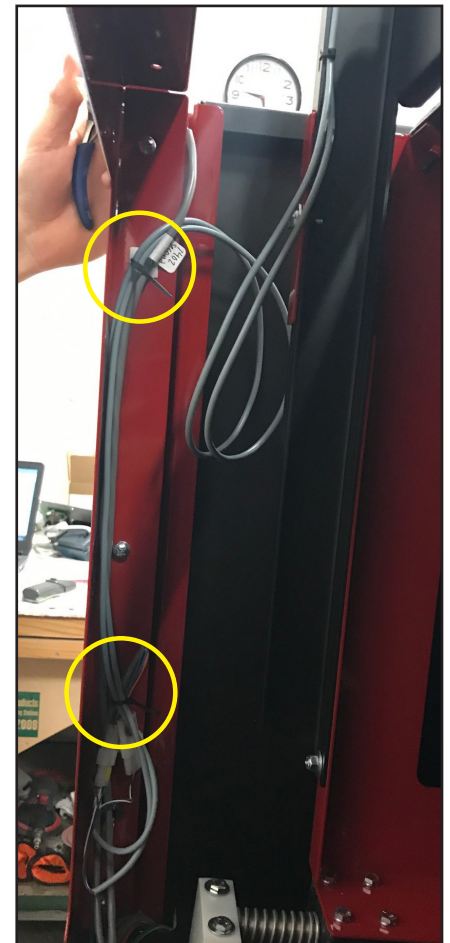

SET UP GUIDE CONT.

Again with assistance, lift the “crowd” backboard up and insert it into the rear of the ramp, behind the clear backboard. BE CAREFUL NOT TO PINCH THE CABLES!

Run the cables through the cut out on the metal piece, above the ‘NOTICE’ decal.



Plug cable 7429 from the backboard into cable 7402.

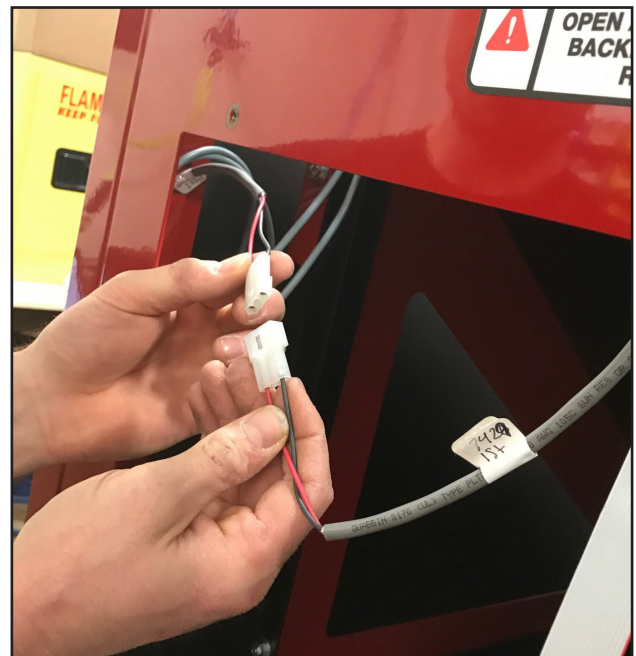

SET UP GUIDE CONT.

Secure the 7429 to the sticky tab up inside the rear of the ramp using a zip tie included in the hardware kit.

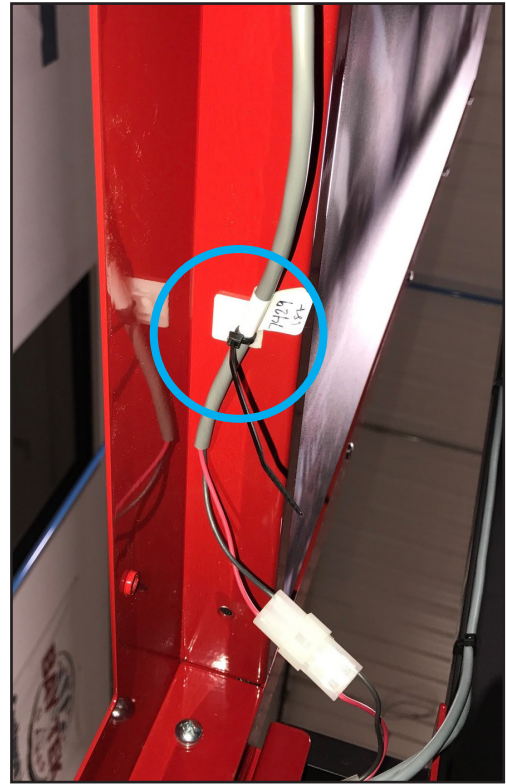

Plug ribbon cable 7419 from the backboard into the housing located on the back, bottom right side of the ramp.



SET UP GUIDE CONT.

Secure the ribbon cable to the sticky tabs up inside the rear of the ramp using zip ties included in the hardware kit.

****BE CAREFUL TO NOT TIGHTEN THE ZIP TIES TOO TIGHTLY AROUND THE RIBBON CABLE - THIS WILL CAUSE DAMAGE TO THE CABLE!**

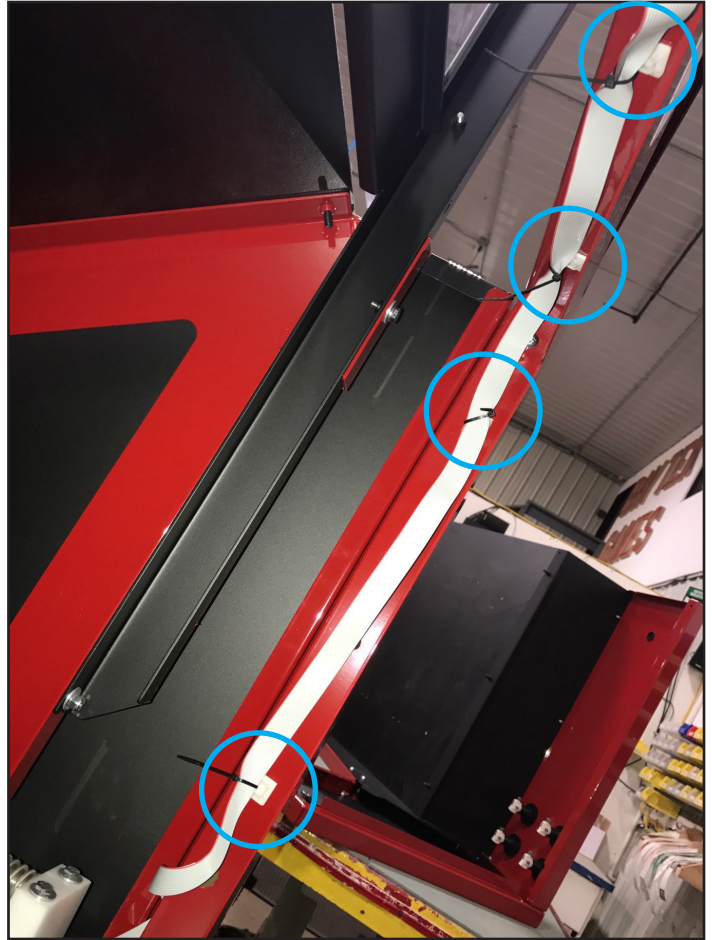

In the front of the ramp, lift and insert the ball stop acrylic piece.

Install so the acrylic piece sits flush with the top of the display section.



SET UP GUIDE CONT.

Get four bolts and four lock washers from the hardware kit.



Insert two bolts and two washers on each side to secure the ball stop acrylic in place.

Tighten all bolts.

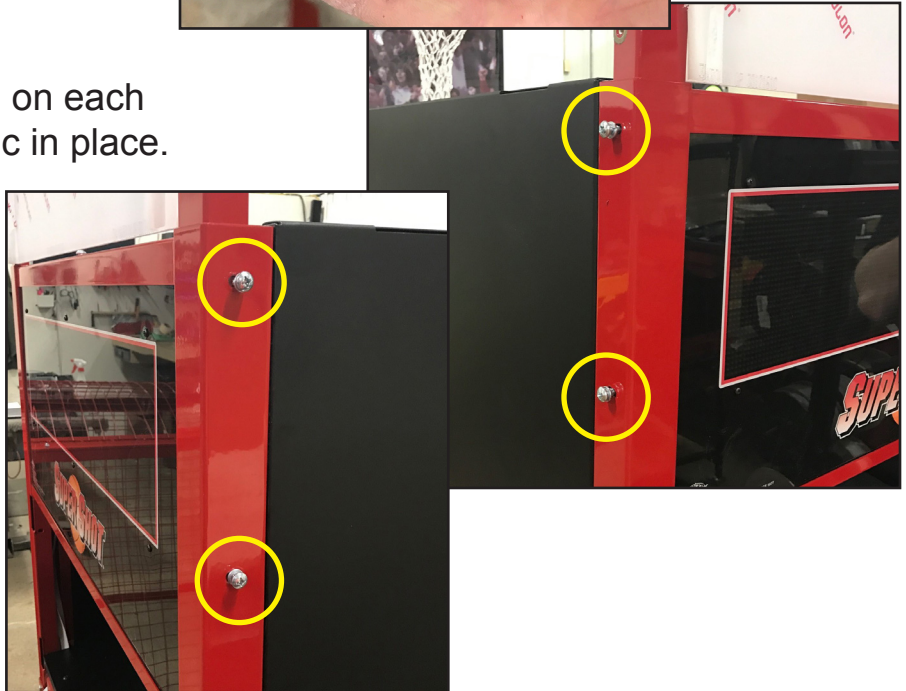

With assistance, lift the cage on top of the ramp.

Insert the notches on the bottom of the cage, into the cut outs in the top of ramp.

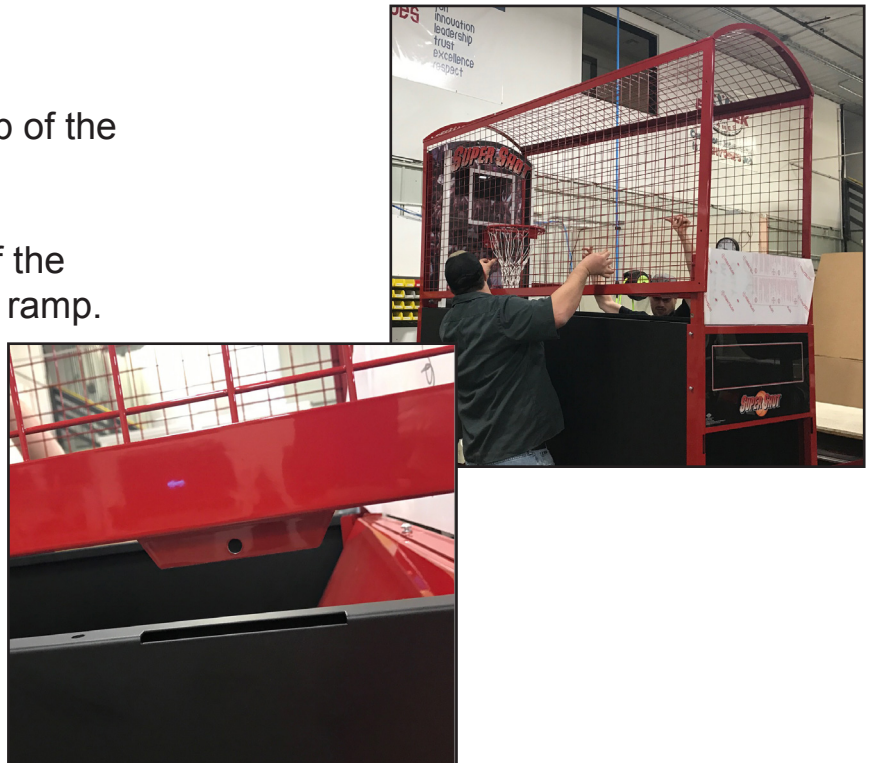

SET UP GUIDE CONT.

Get ten bolts from the hardware kit to secure the cage in place.

There will be two bolts in the front of the cage and three in the rear (circled in yellow in the diagrams). Insert the bolts and secure the cage.

Repeat this for both sides of the cage.



Remove the protective film from the ball stop acrylic.



SET UP GUIDE CONT.

With assistance, lift and set the console section in front of the ramp.



Lift the console and insert the tabs on the rear of the console, into the cut outs on the front of the ramp.

Lift the console at the front to lock the tabs down into the cut outs.

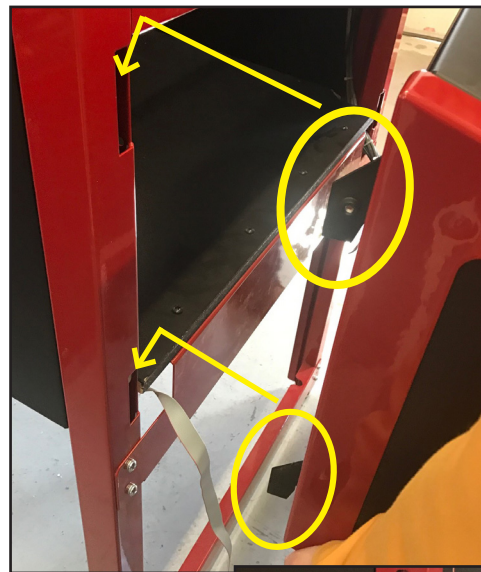

SET UP GUIDE CONT.

Inside of the ball return area, you will need to secure the console to the ramp.

Use the bolts and lock washers from the hardware kit. There will be a washer and bolts inserted into each side.

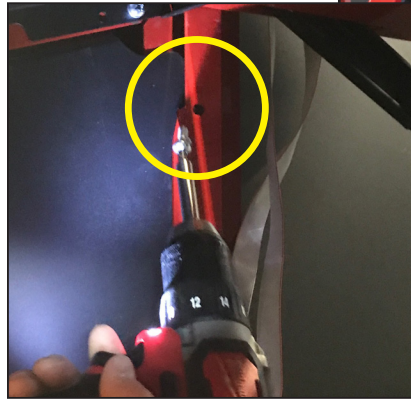

Plug in the cable bundle from the console to the cable bundle from the ramp. Each cable will only have one match so they can not be mixed up.

Route the ribbon cable from the ramp through the hole on the back of the console and down into the console.

Secure the excess ribbon cable into the saddles on the bottom of the console.

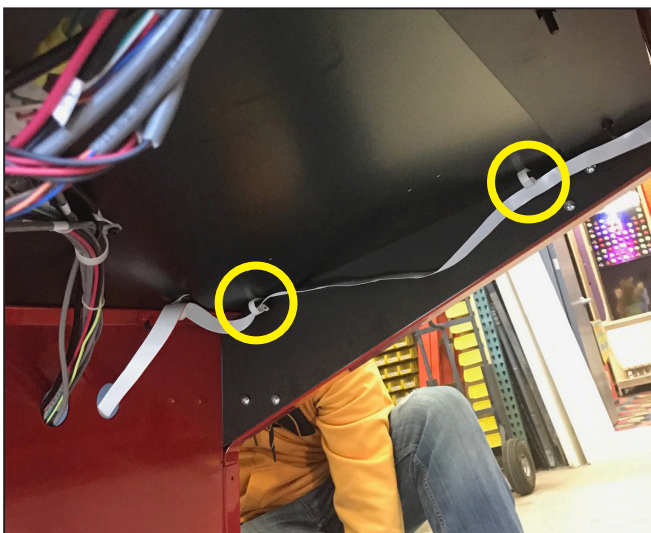

SET UP GUIDE CONT.

Route the power cable through the hole on the back of the console and down into the console.

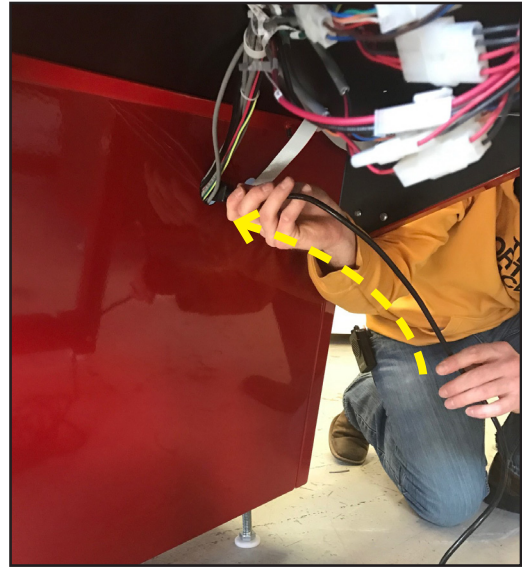

Inside the console, route and plug in the power cable to the line filter box.

Route and plug in the ribbon cable to the housing on the CB3904 circuit board. This location is also labeled.

Plug remaining end of power cable into a standard power outlet. You are now ready to play ball!

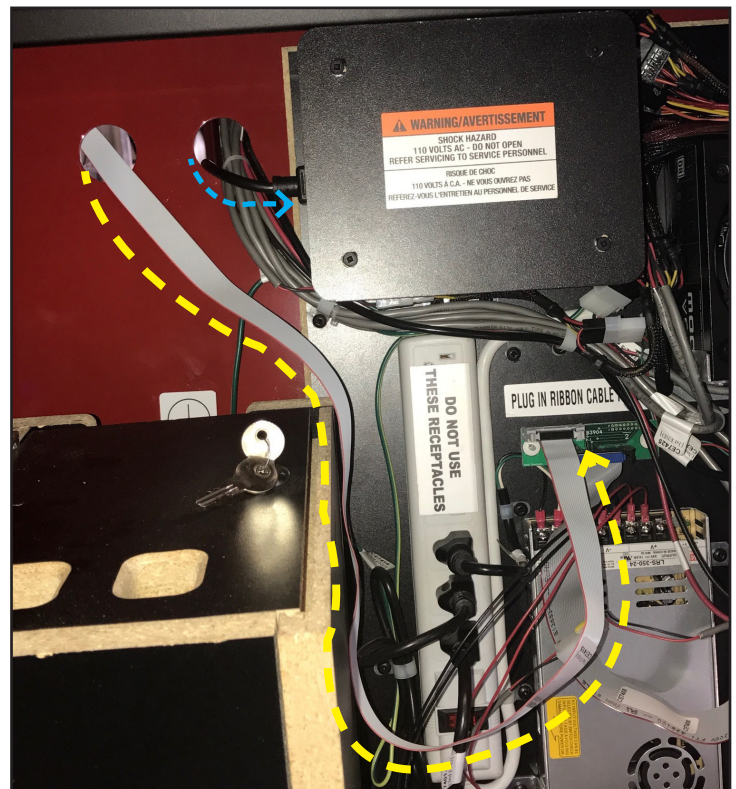

(The blue colored phone cable port on the main board inside the console is where you will link multiple games together or connect a jackpot sign)

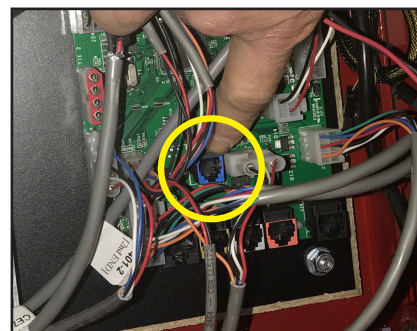

HOW TO: INSTALL LINKING KIT

Open the linking kit box and remove the gray phone cables.

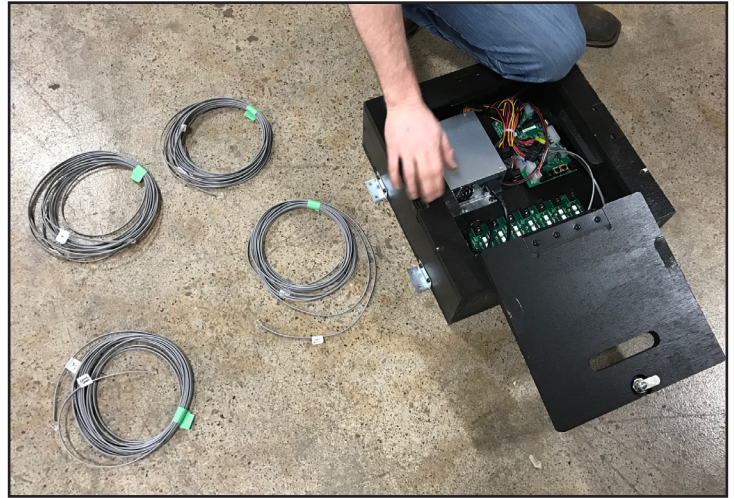

Plug in the black power cable to the power supply and route through the cut out in the box on the opposite side of the door hinge.

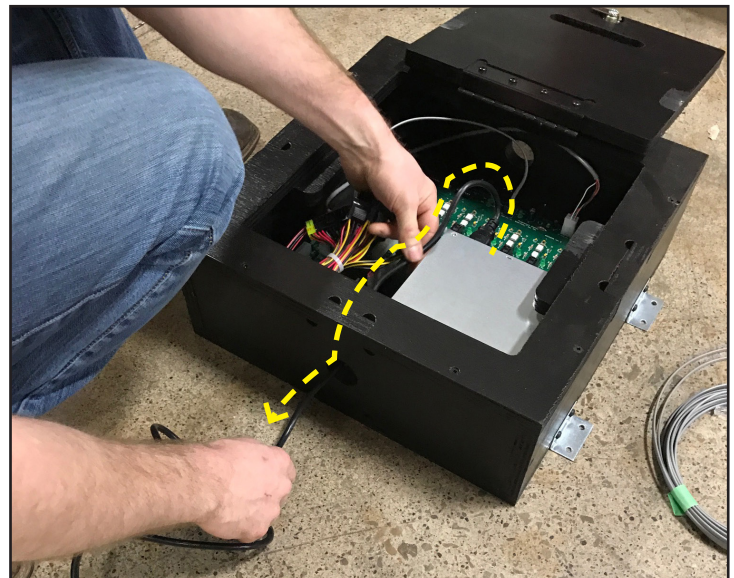

Each game in the bank will require it's own phone cable. Route the needed cables through the cut out in the black box on the same side as the hinge for the door.



HOW TO: INSTALL LINKING KIT CONT.

Plug each of the phone cables into the phone ports on the Multi-plexer board inside the linking box.

Close the cover on the linking box when all phone cables are plugged in.



Under the ball return ramp area, unplug all the wire housings and use a drill to remove the screw in the clamp that is holding the bundle of cables up.

Move the bundle of cables to the side.



Locate the hardware kit in the cash box with the black 10 screws inside.



Use the screws to attach the linking box to any of the games in the bank, under the ball return ramp - use the pilot holes.



HOW TO: INSTALL LINKING KIT CONT.

Reconnect all of the cables that you disconnected earlier under the ball return ramp.

Plug the power cable from the linking box into a standard power outlet.

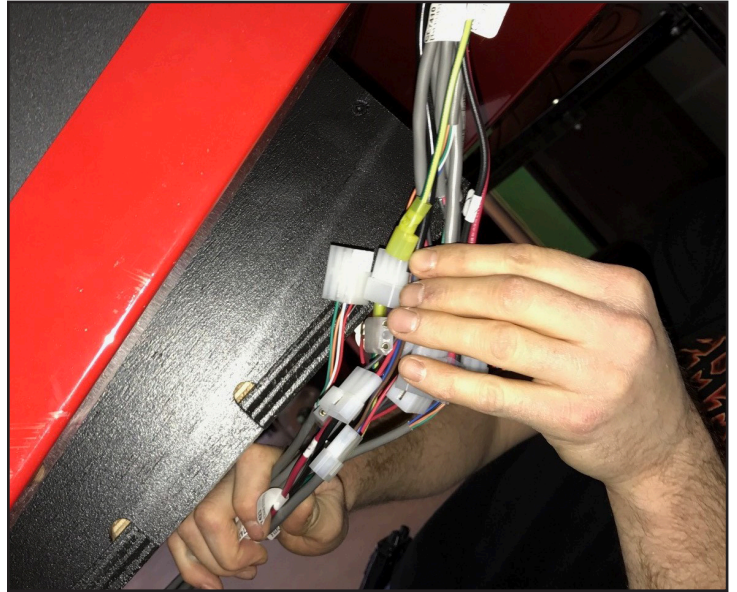

Feed one phone cable from the linking box into each of the game consoles. Insert the phone cable through the hole cut out on the back side of the console.

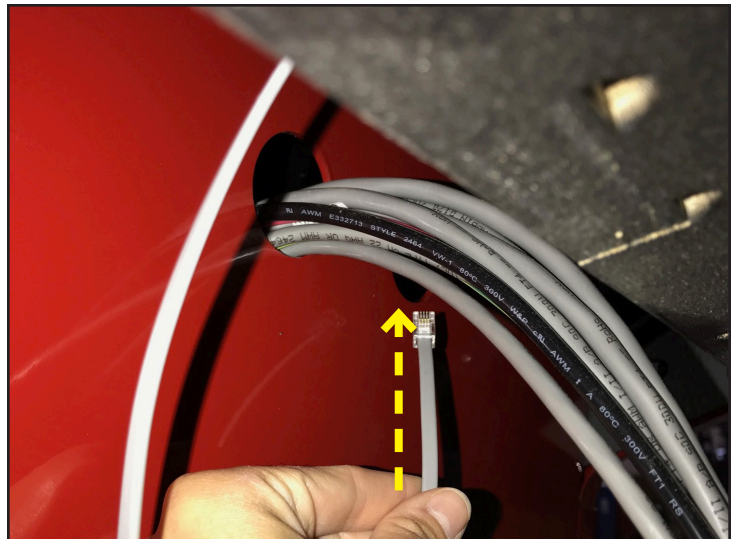

Inside the console of each game, plug the phone cable into the blue phone port on the main board.

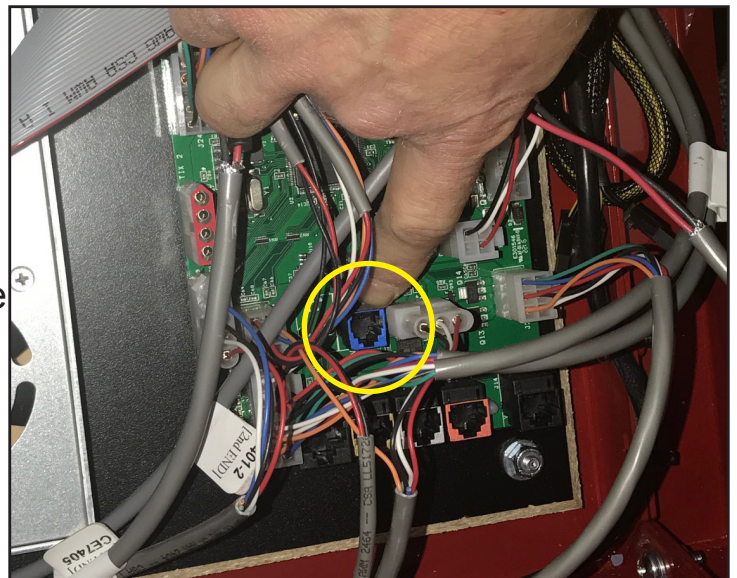

DIP SWITCH SETTINGS

The dip switch bank is located on the mainboard, inside the front door of the game.

*factory default settings are highlighted below

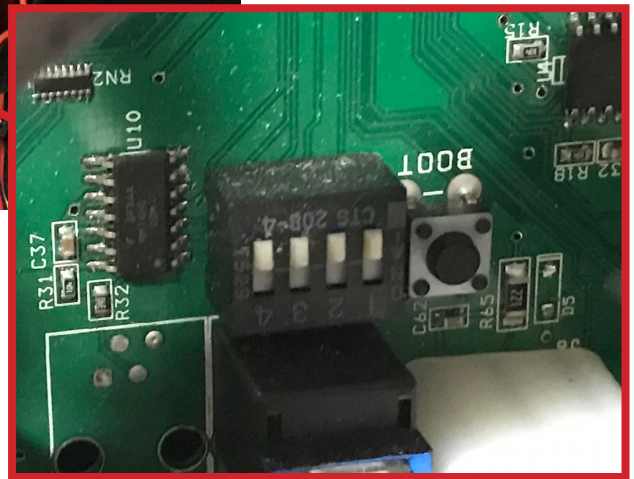
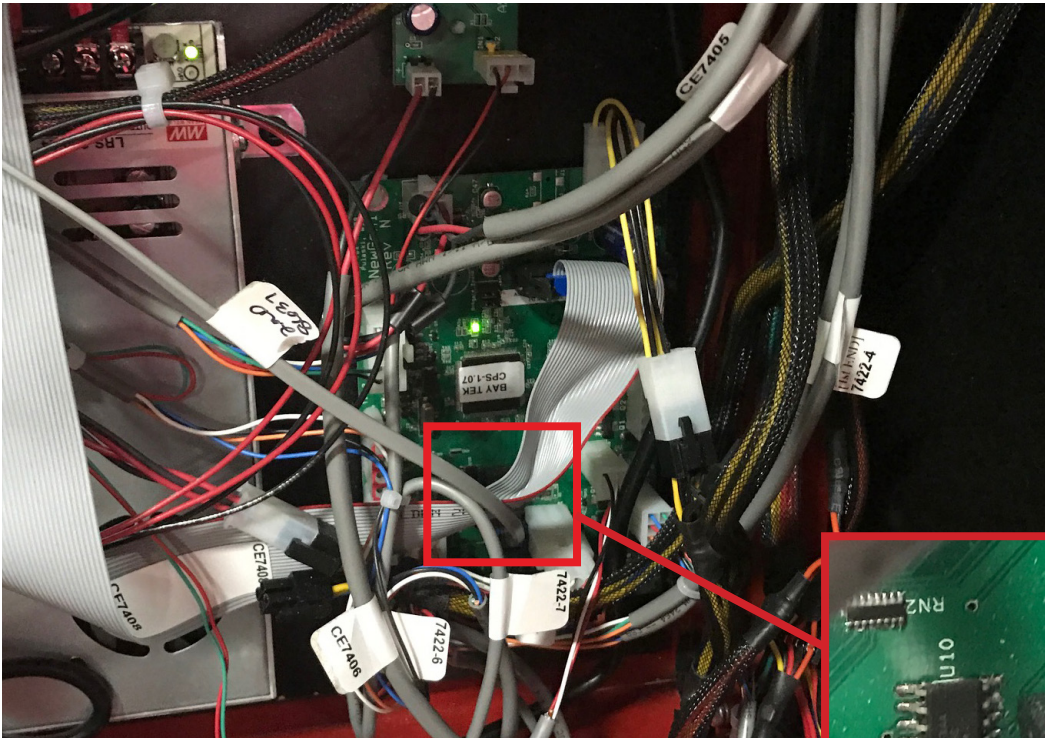

SWITCH	DESCRIPTION	ON	OFF
1	STATIONARY		X
2	JERSEY SHORE		X
3	D&B DEFAULTS		X
4	MANUFACTURER SETTINGS		X

MAIN MENU FUNCTIONS

Press the MENU button inside the front door to enter the game menu.

Scroll through the menu options using the MENU button.

Make your selections with the MENU SELECT button.

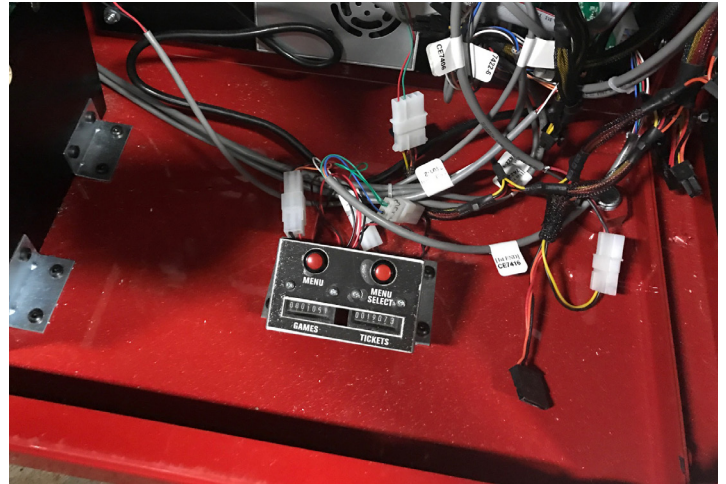

MENU	DESCRIPTION
N1	CREDITS PER PLAY
N2	ATTRACT VOLUME
N3	GAME VOLUME
N4	ATTRACT TIMING
N5	JOIN IN TIME DELAY
N6	GAME LENGTH
N7	THREE POINT TIME
N8	POINTS NEEDED FOR BONUS TIME
N9	BONUS TIME REWARDED
N10	BONUS TIME MODE
N11	POINTS PER TICKET
N12	DOUBLE TICKETS
N13	MINIMUM TICKETS PER GAME
N14	JACKPOT INCREMENT
N15	JACKPOT DECREMENT
N16	JACKPOT MINIMUM
N17	JACKPOT MAXIMUM
N18	MINIMUM HIGH SCORE

N1- CREDITS PER PLAY

Scroll through the N1 menu with the “MENU” button.
Make your selection with the “SELECT” button.
The factory settings are highlighted below.

ADJUSTABLE IN INCREMENTS OF 1			
0	TO	20	4 DEFAULT

N2- ATTRACT VOLUME

Scroll through the N2 menu with the “MENU” button.
Make your selection with the “SELECT” button.
The factory settings are highlighted below.

0	1	2	3	4	5	6	7	8	9	10
---	---	---	---	---	---	----------	---	---	---	----

N3- GAME VOLUME

Scroll through the N3 menu with the “MENU” button.
Make your selection with the “SELECT” button.
The factory settings are highlighted below.

0	1	2	3	4	5	6	7	8	9	10
---	---	---	---	---	---	----------	---	---	---	----

N4- ATTRACT TIMING

Scroll through the N4 menu with the “MENU” button.
Make your selection with the “SELECT” button.
The factory settings are highlighted below.

This setting determines how often the attract audio loop is played.

0	1	2	3	4	5	6	7	8	9	10
in minutes										

N5- JOIN IN TIME DELAY

Scroll through the N5 menu with the “MENU” button.
Make your selection with the “SELECT” button.
The factory settings are highlighted below.

This setting determines how much time additional players have to credit and join in game play once a competition is started by the first player. Game will automatically start after the set amount of time is reached.

ADJUSTABLE IN INCREMENTS OF 1			
5	TO	15	10 DEFAULT
in seconds			

N6- GAME LENGTH

Scroll through the N6 menu with the “MENU” button.
Make your selection with the “SELECT” button.
The factory settings are highlighted below.

This option sets the base time for game play.

ADJUSTABLE IN INCREMENTS OF 5			
15	TO	85	45 DEFAULT
in seconds			

N7- THREE POINT TIME

Scroll through the N7 menu with the “MENU” button.
Make your selection with the “SELECT” button.
The factory settings are highlighted below.

This option sets the period of time that each made basket is worth 3 points.

ADJUSTABLE IN INCREMENTS OF 1			
0 (disabled)	TO	30	15 DEFAULT
in seconds			

N8- POINTS NEEDED FOR BONUS TIME

Scroll through the N8 menu with the “MENU” button.
Make your selection with the “SELECT” button.
The factory settings are highlighted below.

This setting determines the amount of points needed to be scored during regular game play to receive the additional bonus time.

ADJUSTABLE IN INCREMENTS OF 5			
0	TO	65	20 DEFAULT

N9- BONUS TIME REWARDED

Scroll through the N9 menu with the “MENU” button.
Make your selection with the “SELECT” button.
The factory settings are highlighted below.

This will set the amount of bonus time awarded to a player who scores the required amount of points.

ADJUSTABLE IN INCREMENTS OF 1			
0 (disabled)	TO	25	5 DEFAULT
in seconds			

N10- BONUS TIME MODE

This option allows the player to get additional playing time.

OFF: No additional time can be earned

EVERY XX POINTS: In this mode a player will receive extra time every XX points (see “points needed for bonus time”) NOTE: in this mode, all tournament players get additional time each time any of the players gets additional time.

ONCE: The player can get extra time, but only once.

OFF	EVERY XX POINTS	ONCE
------------	----------------------------	-------------

N11- POINTS PER TICKET

Scroll through the N11 menu with the “MENU” button.

Make your selection with the “SELECT” button.

The factory settings are highlighted below.

Sets the amount of points required to pay out one ticket. Setting to ‘0’ is setting to the non-redemption mode.

4 DEFAULT	ADJUSTABLE IN INCREMENTS OF 1		
	0 <small>(non-redemption mode)</small>	TO	10
	ADJUSTABLE IN INCREMENTS OF 2		
	12	TO	20
	ADJUSTABLE IN INCREMENTS OF 5		
	25	TO	50

N12- DOUBLE TICKETS

Scroll through the N12 menu with the “MENU” button.

Make your selection with the “SELECT” button.

The factory settings are highlighted below.

NO	YES
-----------	-----

N13- MINIMUM TICKETS DURING GAME

Scroll through the N13 menu with the “MENU” button.
Make your selection with the “SELECT” button.
The factory settings are highlighted below.

This will set the minimum amount of tickets a player will win regardless of how many points they score or how other ticket options in the game might be set.

ADJUSTABLE IN INCREMENTS OF 1			
0 (disabled)	TO	10	0 DEFAULT

N14- JACKPOT INCREMENT

Scroll through the N14 menu with the “MENU” button.
Make your selection with the “SELECT” button.
The factory settings are highlighted below.

The jackpot value will grow by this amount with each game played that the jackpot is not won.

ADJUSTABLE IN INCREMENTS OF 1			
0 (disabled)	TO	10	1 DEFAULT

N15- JACKPOT DECREMENT

Scroll through the N15 menu with the “MENU” button.
Make your selection with the “SELECT” button.
The factory settings are highlighted below.

This option is used to help players that are not as skilled as others or for use when the jackpot win value becomes too high for normal players to win. With this option enabled, the points needed to win the jackpot tickets will decrease by 1 every XX (selected amount) of games. The value will eventually drop as low as 20 if necessary but will then return to the ‘minimum high score’ number.

ADJUSTABLE IN INCREMENTS OF 1			
0 (disabled)	TO	10	0 DEFAULT

N16- JACKPOT MINIMUM

Scroll through the N16 menu with the “MENU” button.
 Make your selection with the “SELECT” button.
 The factory settings are highlighted below.

This option sets the minimum amount of tickets that will be won if the player matches or breaks the jackpot points to win amount.

100 DEFAULT	ADJUSTABLE IN INCREMENTS OF 50		
	100	TO	1000
	ADJUSTABLE IN INCREMENTS OF 100		
	1100	TO	2000
	ADJUSTABLE IN INCREMENTS OF 250		
	2250	TO	5000

N17- JACKPOT MAXIMUM

Scroll through the N17 menu with the “MENU” button.
 Make your selection with the “SELECT” button.
 The factory settings are highlighted below.

As the jackpot amount progresses, this option will cap the amount of tickets that can be won if a player matches or break the jackpot points to win amount.

1000 DEFAULT	ADJUSTABLE IN INCREMENTS OF 50		
	100	TO	1000
	ADJUSTABLE IN INCREMENTS OF 100		
	1100	TO	9999

N18- MINIMUM HIGH SCORE

Scroll through the N18 menu with the “MENU” button.
Make your selection with the “SELECT” button.
The factory settings are highlighted below.

This option will set the starting minimum score needed to win the jackpot amount.

60 DEFAULT	ADJUSTABLE IN INCREMENTS OF 1		
	0	TO	10
	ADJUSTABLE IN INCREMENTS OF 2		
	12	TO	30
	ADJUSTABLE IN INCREMENTS OF 5		
	35	TO	50
	ADJUSTABLE IN INCREMENTS OF 10		
	60	TO	180

N19- HIGH SCORE RESET

Press the MENU SELECT button 3 times to clear the current high score and reset to the minimum high score.

N20- RESET SETTINGS

Press the MENU SELECT button 3 times to reset all settings to the factory defaults.

DIAGNOSTICS

Pressing the game select buttons on the cabinet will cause the green square to turn red for the corresponding button (A,B,C,D).

Each button also performs the following actions:

A= Raise Ball Release

B= Lower Ball Release

C= Send backboard to front limit

D= Send backboard to back limit

t,b,e,l are informational.

e = Encoder status. Green is idle. Flashing green/red is actively reading.

l = red is limit switch active, green is clear

t = top ball sensor blocked is red, green is clear

b = bottom ball sensor blocked is red, green is clear



Diagnostic motor flag: enables motor status indicator during game play in the lower left corner

Green = idle

Yellow = active

Red = fault



MAIN BOARD WIRING PIN OUT

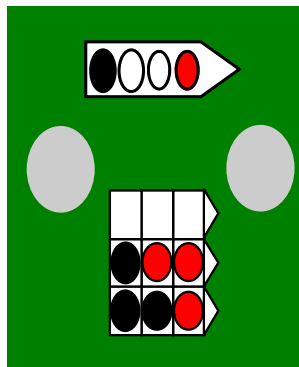

A5CB9507
Motor Driver Board



AACB3906
Actuator Driver Board

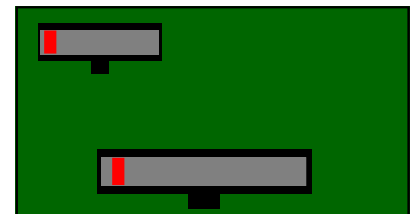

AACB3904
Splitter Board

WIRING DIAGRAMS

AC POWER, 5V & 12V POWER

A5CB9507
Motor Driver Board

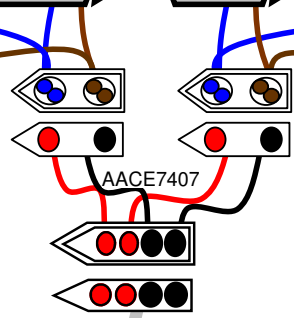
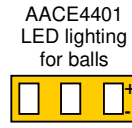
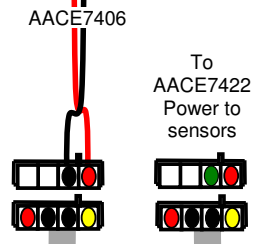
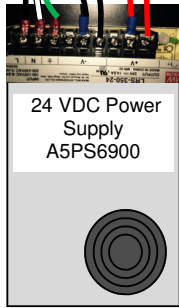
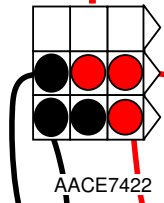
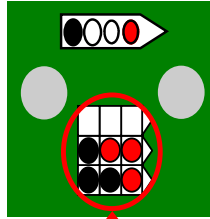

AACE7424

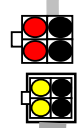

AACE9413

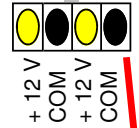

To J18 on Board

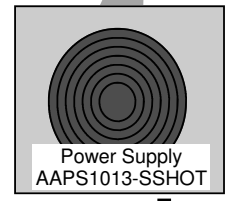
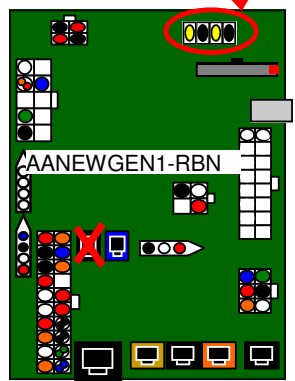

AC Power to Power Supply A5CORD5

AACE4733

AACE7401 Bill Acceptor Cable



Power Strip AACE9407

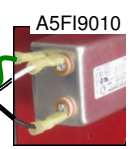

A5CORD29 Power In Cord

WIRING DIAGRAMS

DISPLAY WIRING

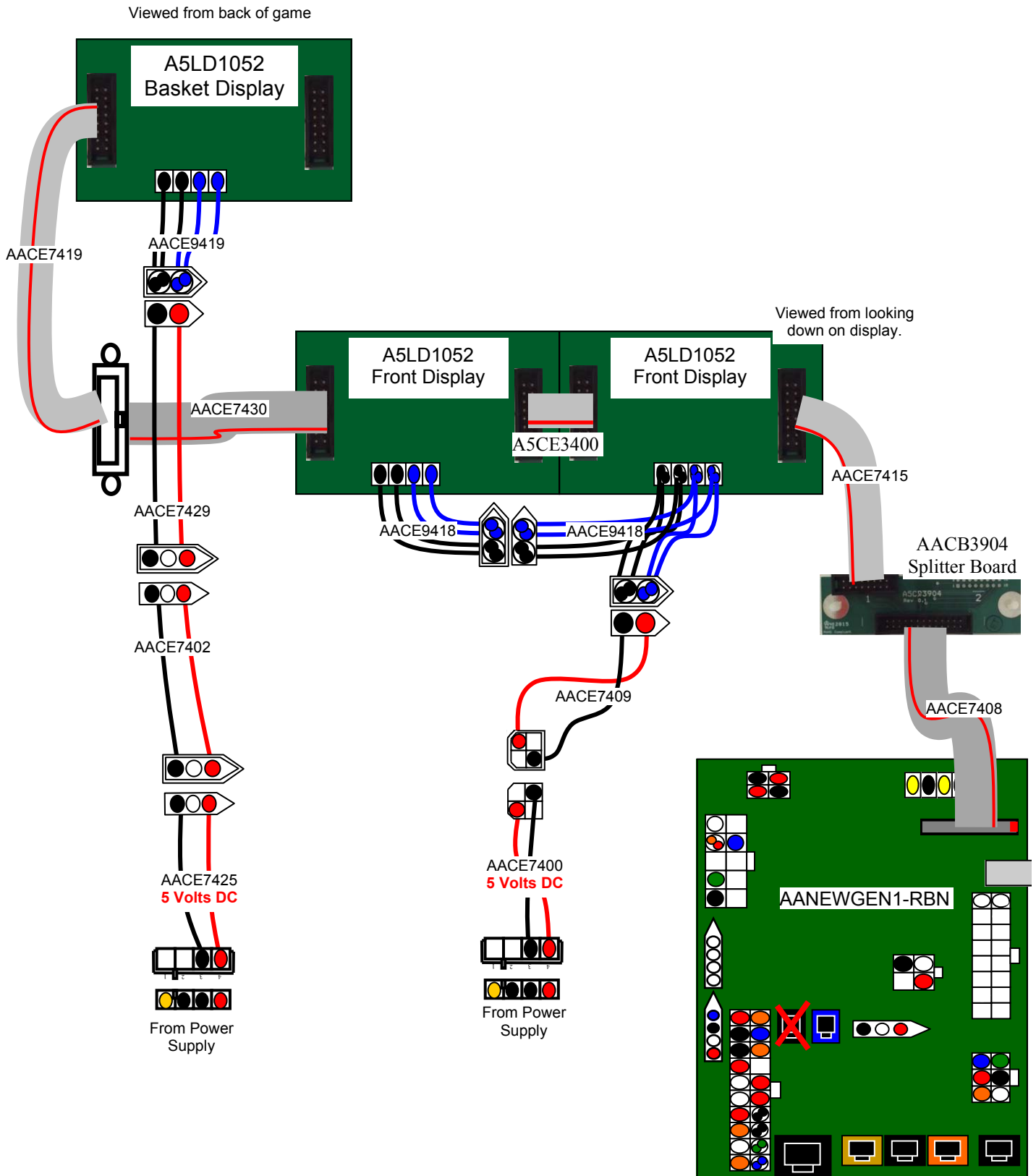

WIRING DIAGRAMS

HOOP SENSORS, TICKET DISPENSER, MENU, DBA, METERS, SPEAKER

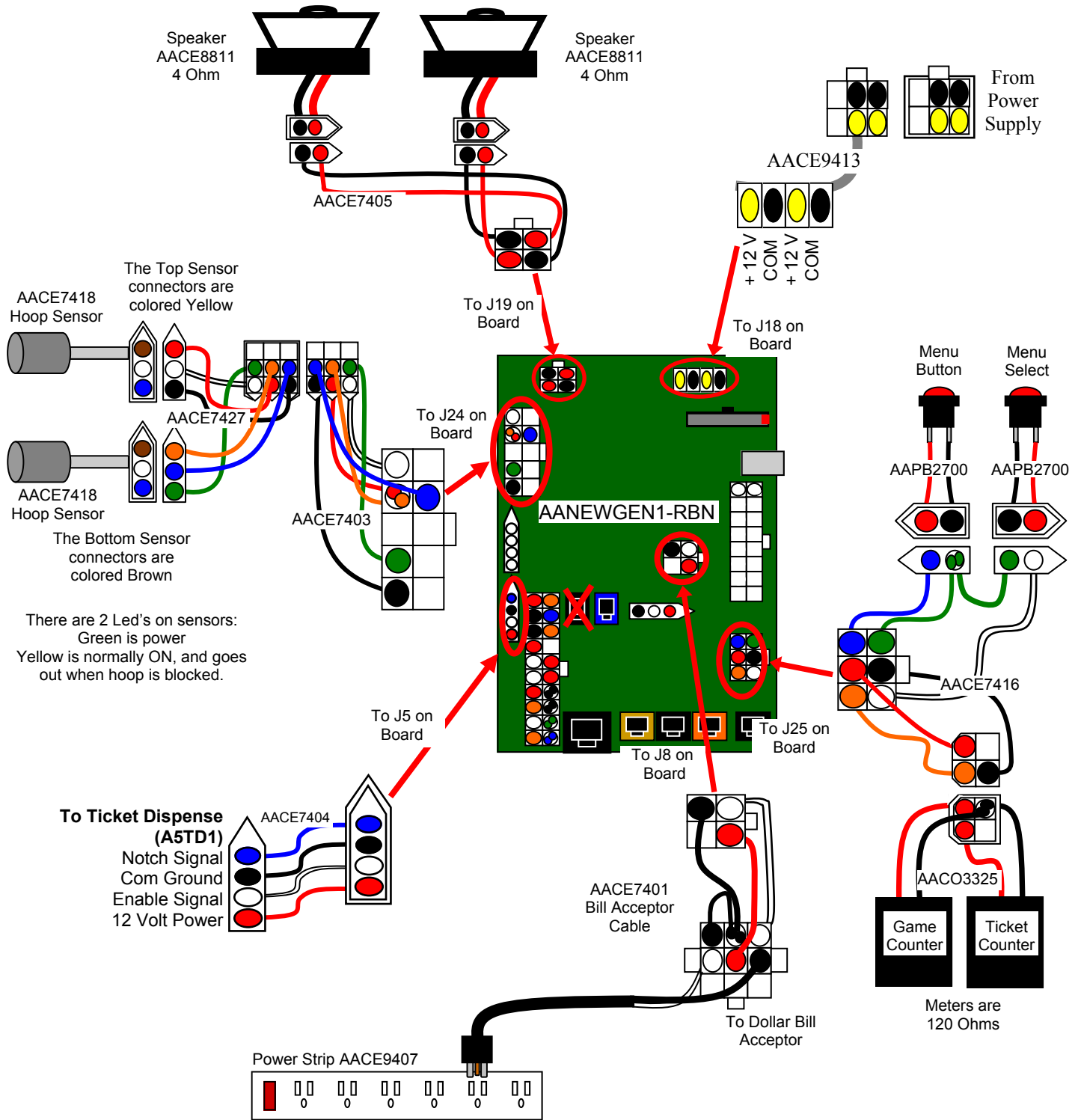

TROUBLE SHOOTING GUIDE

Problem	Probable Cause	Remedy
No power to the game.	Unplugged. Power strip turned off, or plugs unplugged. Circuit breaker tripped. Line filter faulty. Bad or overloaded power supply.	Check wall outlet cable (A5CORD29) to line filter in back of front console of game. (A5FI9010) Check rocker switch on power strip. Ensure power cords are pushed up into power strip securely. Reset power strip breaker switch or building circuit breaker. Attempt to determine cause. Replace line filter. (A5FI9010) Refer to Power Supply Diagnostics
Bill Acceptor on, but everything else off. (Power Supply not ON)	Power supply unplugged. Rocker Switch on power supply is Off. Power supply shutting down because of 12 V overload. Faulty power supply.	Insure power supply is plugged into power strip. Make sure rocker switch is set ON. See power supply diagnostics to isolate bad component. A bad motor or 12 volt short would cause this. Refer to Power Supply Diagnostics section.
LED lights in ball area are not working.	LED strip faulty Faulty Cable	Remove front display plexi (Refer to: How Access Display, Spotlights, and Actuator) and examine LED strip. (AACE4401) Check cables from LED strip to power supply. (AACE4401, AACE7431, AACE7407, AACE7424)
LED target Cabinet spot lights lighting not working.	LED spotlight faulty Faulty Cable	Remove front display plexi (Refer to: How Access Display, Spotlights, and Actuator) and examine LED spotlight. Swap power cables from the other spotlight. Replace if needed. (AACE7431) Check cables from LED spotlight to power supply. (AACE7431, AACE7407, AACE7424)
Dollar Bill Acceptor not functioning.	Ensure bill acceptor has 110 Volts AC. Dirt or debris in acceptor slot. Ensure acceptor dipswitch is set to "always enable" Pinched, broken, or disconnected wiring. Bill acceptor problem.	Acceptor should cycle stacker at game power up. If not, check cable connections to power strip. Caution – 110 Volts AC Clean with bill reader cleaning card. (A5CC9000) There are dips on side of acceptor. Set to "always enable" (not harness enable) Check wiring from bill acceptor to main board. Repair or replace wiring harness. (AACE7401) Refer to troubleshooting section of dollar bill acceptor manual included with this game or the diagnostics label of the back of the unit.

TROUBLE SHOOTING GUIDE CONT.

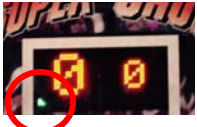
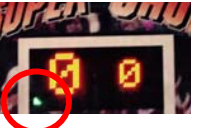
Problem	Probable Cause	Remedy
<p>Game does not coin up</p> <p>Game should have an audio doink sound from speakers when coin switch is triggered.</p>	<p>Card Swipe System Special Instructions-</p> <p>Pinched, broken, or disconnected wiring.</p> <p>Faulty Coin Mechanism. Swap coin mech to verify.</p> <p>Faulty Main Board</p>	<p>Set "Game drive voltage threshold" to 2 volts. Coin signal are white and black wires.</p> <p>Check connections from coin switches to "Coin" connector on main board. Check continuity on wires. (AACE7422, AACBL4A-DOOR)</p> <p>Replace coin mech if faulty.</p> <p>Replace main board. (AANEWGEN1-RBN)</p>
<p>Tickets do not dispense.</p>  <p>Green triangle on rear display signifies "Low tickets"</p>	<p>Ticket tray empty due to faulty low ticket switch or broken/ loose wires. Switch stuck or switch wire bent out of position.</p> <p>Faulty cable to dispenser.</p> <p>Dirty opto-sensor or paper dust buildup in ticket dispenser</p> <p>Notch on tickets too shallow.</p> <p>Ticket dispenser faulty.</p> <p>Main circuit board malfunction.</p>	<p>Fill ticket tray. Replace low ticket switch(AASW200). Repair wiring. Clean ticket tray of dirt, loose tickets or debris. Bend switch wire to correct position under tickets.</p> <p>Check wiring continuity from dispenser to main board (AACE7422) Check for pinched, broken or disconnected wires. Replace as necessary.</p> <p>Clean with compressed air and if necessary wipe sensor with isopropyl alcohol on a cotton swab.</p> <p>Flip tickets and load upside-down to have large cut notch toward opto sensor.</p> <p>Replace dispenser with spare working dispenser (A5TD1)</p> <p>Replace main board if possible to isolate the problem to the main circuit board. (AANEWGEN1-RBN)</p>
<p>Wrong number of tickets dispensed.</p>	<p>Ticket Pattern set wrong.</p> <p>Dirty opto-sensor on ticket dispenser.</p> <p>Notch on tickets cut too shallow.</p> <p>Faulty ticket dispenser.</p> <p>Main circuit board malfunction.</p>	<p>Enter menu and verify correct settings for Ticket Pattern</p> <p>Clean with compressed air or wipe with isopropyl alcohol on a cotton swab.</p> <p>Flip tickets and load upside-down to have large cut notch toward opto sensor.</p> <p>Replace with spare working dispenser (A5TD1).</p> <p>Swap cable from one output on main board to the other to verify cable/dispenser problem or faulty main board. (AANEWGEN1-RBN)</p>
<p>Low tickets</p> 	<p>Stack of tickets not resting properly on low ticket switch.</p> <p>Faulty switch.</p> <p>Faulty wire or connection.</p> <p>Faulty main board.</p>	<p>Adjust stack of tickets so they hold both the switch actuators down.</p> <p>Replace low ticket switch. (AASW200)</p> <p>Check for proper connection from switch to main board. Check continuity. (AACE7422)</p> <p>Replace main board. (AANEWGEN1-RBN)</p>

BALLS NOT RELEASING

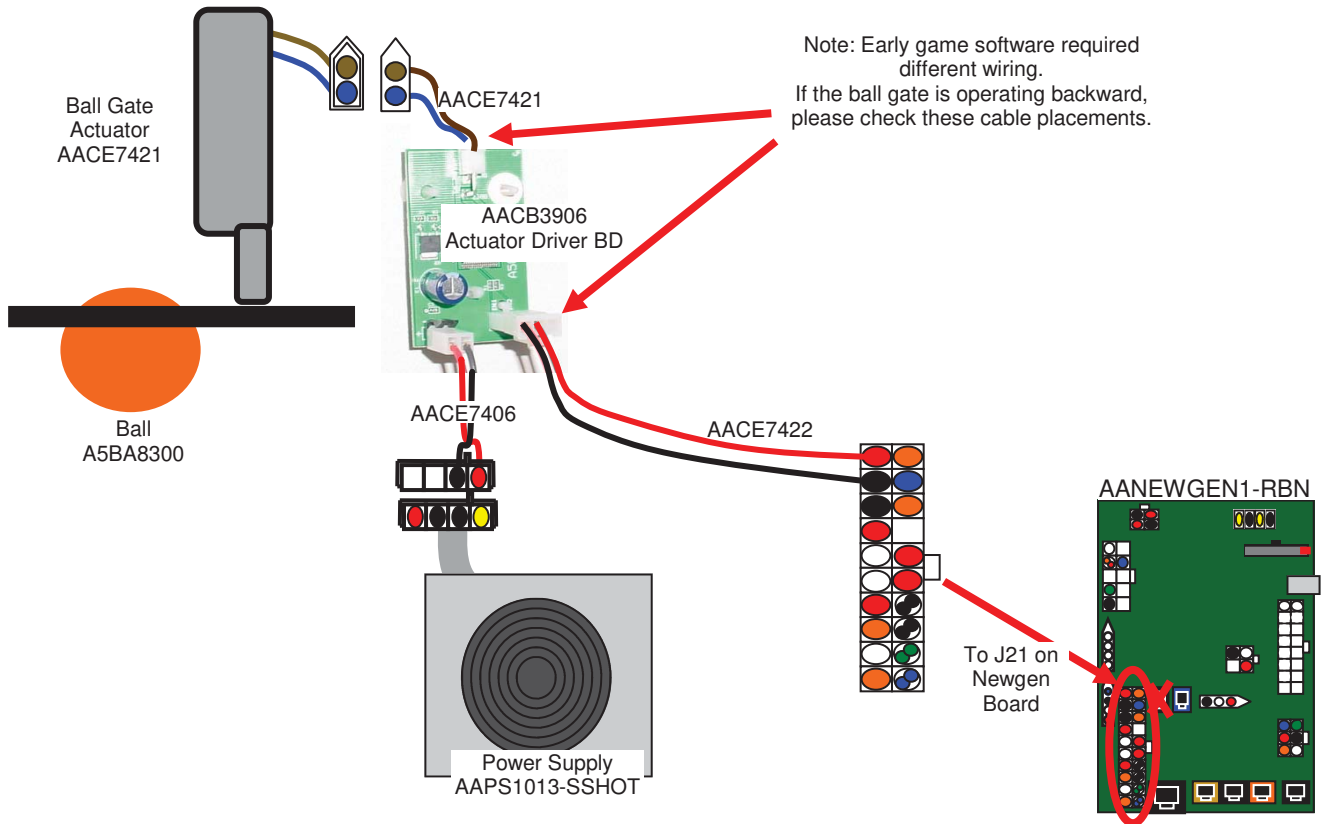

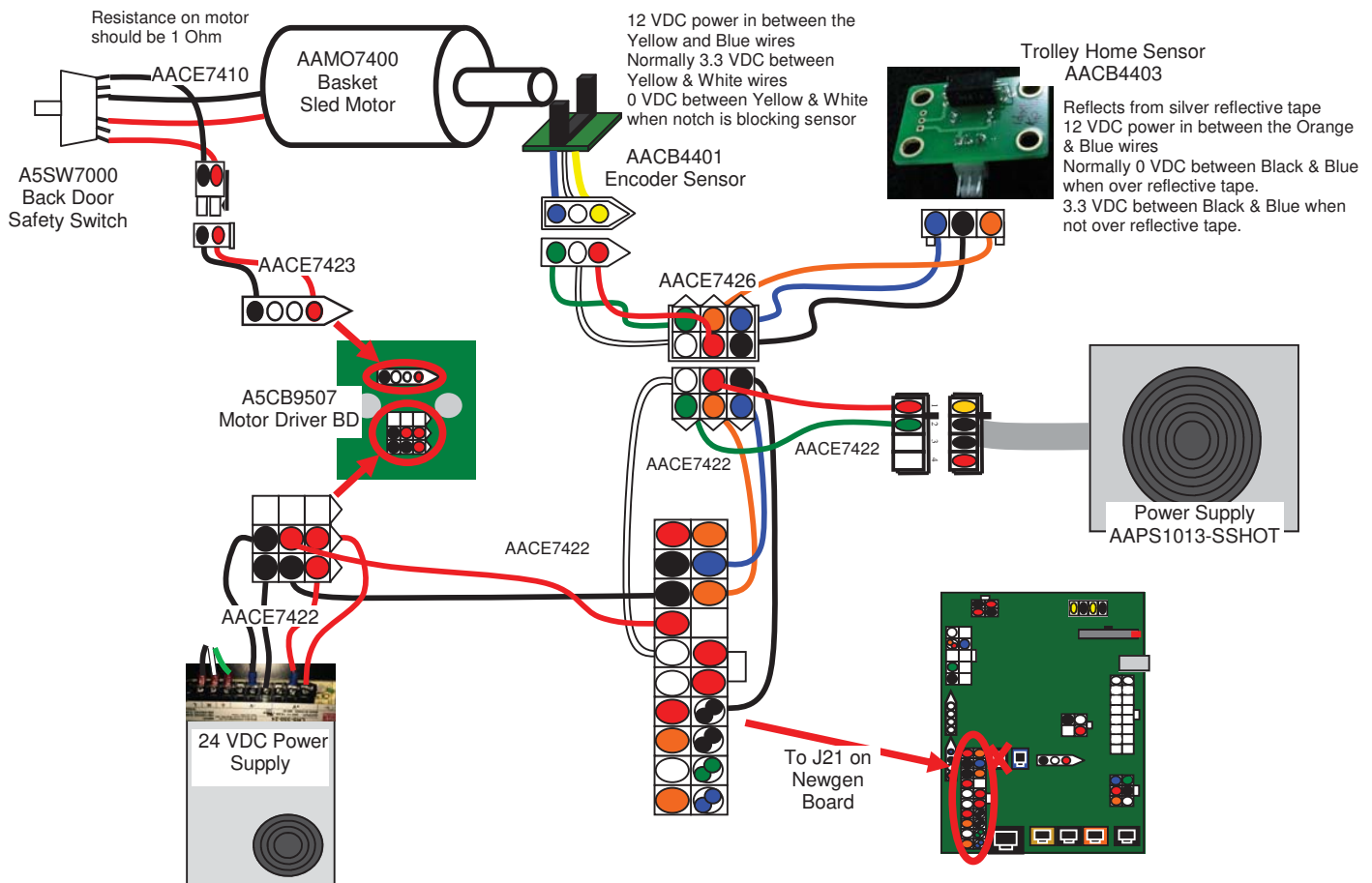

Problem	Probable Cause	Remedy
<p>Balls are not being released or are always coming down.</p> <p>Ball gate should move down to home position at power on.</p> <p>If ball gate is operating backward, then check wires as noted above.</p>	<p>Mechanical issue causing ball gate to stick.</p> <p>Check for voltage at Actuator driver board</p> <p>Check for voltage on cable CE7422</p> <p>Check for voltage on cable CE7421</p> <p>Faulty wire or connection.</p>	<p>Check for free movement of assembly with actuator not attached. To access actuator, refer to: How Access Display, Spotlights, and Actuator</p> <p>Cable CE7405 should have +12 VDC at all times.</p> <p>Enter Diagnostic Menu - (Button A lowers bar, Button B raises bar)</p> <p>Check voltage on CE7422 into actuator driver board: It should be -3 VDC when bar is moving up. It should be +3 VDC when bar is moving down.</p> <p>Enter Diagnostic Menu - (Button A lowers bar, Button B raises bar)</p> <p>Check voltage on CE7421 from actuator driver board: Black meter lead on brown wire, red meter lead on blue wire. This cable must be plugged in for reading to be accurate. It should be -12 VDC when bar is moving up and held. It should be +12 VDC when bar is moving down and held</p> <p>Check for proper connection on CE7421 cable molex plug underneath cabinet. Check continuity.</p>

HOOP DOES NOT MOVE



Problem	Probable Cause	Remedy
<p>Basket does not move at all.</p> <p>Hoop should move to back of game home position at power on.</p>	<p>Back door safety interlock switch open.</p> <p>Mechanical or Sensor issue causing hoop to move erratically.</p> <p>Check for voltage at motor driver board</p> <p>Check for voltage on cable CE7422 into motor driver board: It should be -3 VDC when hoop is moving back It should be +3 VDC when hoop is moving forward</p> <p>Check for voltage on cable CE7423 from motor driver board: cable must be plugged in for reading to be accurate. It should be +24 VDC when hoop is moving back It should be -24 VDC when hoop is moving forward</p> <p>Faulty wire or connection.</p>	<p>Check wires to switch. Replace switch A5SW7000</p> <p>Refer to "Basket moves, but it is not moving correctly" section.</p> <p>Cable CE7422 should have +24 VDC at all times from the power supply.</p> <p>Enter Diagnostic Menu - (Button C moves hoop forward, Button D moves hoop backward)</p> <p>Enter Diagnostic Menu - (Button C moves hoop forward, Button D moves hoop backward)</p> <p>Check for proper connection on CE7423, CE7410 cable moxex plug underneath cabinet. Check safety interlock switch on back of cabinet. Check continuity</p>

TROUBLE SHOOTING GUIDE CONT.

Problem	Probable Cause	Remedy
<p>Basket moves, but it is not moving correctly.</p> <p>Trolley needs no lubrication</p> <p>Clean with WD40</p> 	<p>Back door safety interlock switch faulty.</p> <p>“Trolley Init Seeking Home” Error</p>  <p>Basket moves forward, but then doesn't move anymore.</p> <p>Pinched, broken, or disconnected wiring</p>	<p>Check wires to switch. Make sure the back door fully engages the switch. Replace if needed. A5SW7000</p> <p>Motor is not getting power— Refer to “Basket hoop does not move” section.</p> <p>Home sensor is dirty/faulty. Replace if needed. (AACB4403) Check connections from home sensor to main board. Check continuity on wires. (AAACE7426, AAACE7422) Home Sensor “sees” silver reflective tape 12 VDC power in between the Orange & Blue wires Normally 0 VDC between Black & Blue when over reflective tape. 3.3 VDC between Black & Blue when not over reflective tape. Clean reflective tape on bottom of hoop trolley.</p> <p>Encoder sensor is dirty/faulty. Replace if needed. (AACB4401) Check connections from encoder sensor to main board. Check continuity on wires. (AAACE7426, AAACE7422) 12 VDC power in between the Yellow and Blue wires Normally 3.3 VDC between Yellow & White wires 0 VDC between Yellow & White when notch is blocking sensor</p> <p>Inspect crimp to ensure good connection. Check connections from menu buttons to main board. Check continuity on wires. (AAPB2700, AAACE8605)</p>
<p>No Audio</p>	<p>Volume too low.</p> <p>Loose wire.</p> <p>Faulty Main Board</p>	<p>Increase the volume by pressing Menu button, to “Game Volume”</p> <p>Check audio cable connections from main board to speakers. (AAACE8811, AAACE7405)</p> <p>Replace Main Board. (AANEWGEN1-RBN)</p>
<p>Display not working</p>	<p>Refer to wiring diagram - “Display Wiring”</p> <p>5 Volt DC power In is missing.</p> <p>Communication cable issue. Pinched, broken, or disconnected wiring</p> <p>Faulty display board.</p>	<p>Displays are wired in series from the Newgen Board to front displays to the rear display.</p> <p>Check cables from power supply to displays. Check molex connections under cabinet. (AAACE7400, AAACE7409, AAACE9418 for front displays) & (AAACE7425, AAACE7402, AAACE7429, AAACE9419 for rear display.)</p> <p>Check connections from Newgen board to displays. Communication starts from Newgen Board AAACE7408, to splitter board AACB3904, to cable AAACE7415, to front right display board A5LD1052, to jumper cable A5CE3400, to front left display board A5LD1052, to ribbon cable AAACE7430 to back of the game, then to connection board, then ribbon cable AAACE7419 up to the rear display behind the basket. A5LD1052.</p> <p>Swap display boards within game to isolate faulty board.</p>

TROUBLE SHOOTING GUIDE CONT.

Game Scores wrong	<p>Game will score 3 points per basket when hoop is at rear of game, and score 2 points per basket when hoop is closer to player.</p> <p>If game always scores 3 points, the encoder sensor is faulty in rear of game at motor.</p>	<p>Encoder sensor is dirty/faulty. Replace if AACB4401. Check connections from encoder sensor to main board. Check continuity on wires. (AACE7426, AACE7422)</p> <p>12 VDC power in between the Yellow and Blue wires Normally 3.3 VDC between Yellow & White wires 0 VDC between Yellow & White when notch is blocking sensor</p>
Game does not score.	<p>There are 2 hoops sensors. The ball must trigger both sensors from top to bottom for ball to score.</p> <p>Enter Menu, scroll to “Diagnostic Menu” Inspect sensor and look for LED’s on the sensor itself. Pinched, broken, or disconnected wiring.</p> <p>Faulty sensor. Swap sensor with a working sensor to verify.</p>	<p>Ensure both sensors are seeing reflection from silver tape on the front of the hoop. Replace tape if needed. (AA2W500) The top sensor has a yellow colored connector, and the bottom connector has a brown connector.</p> <p>The display will show which hoop sensor is working.</p> <p>There are 2 LED’s on sensors: Green is power, Yellow is normally ON, and goes out when hoop is blocked.</p> <p>Check connections from hoop sensors to main board. Check continuity on wires. (AACE74718, AACE7427, AACE7403)</p> <p>Replace sensor if faulty. Part # AASE7418</p>
Game select buttons do not work.	<p>Enter Menu and scroll to “Diagnostic Menu” Pinched, broken, or disconnected wiring. Faulty button. Swap buttons with a working button to verify. Faulty Main Board</p>	<p>The display will show when a button is activated.</p> <p>Check connections from button switches to main board. Check continuity on wires. (AACE7422)</p> <p>Replace button if faulty. Part # A5PB8300</p> <p>Replace main board. (AANEWGEN1-RBN)</p>
Game select button lights do not work.	<p>Lights are on all the time. Pinched, broken, or disconnected wiring Faulty button light. Swap buttons with a working button to verify.</p>	<p>They are supposed to stay on all the time. Check connections from button lights to main board. Check continuity on wires. (AACE7422)</p> <p>Replace button if faulty. Part # A5PB8300</p>
Meters do not work Game counter clicks at end of each game. Ticket counter clicks as tickets come out of game.	<p>The 2 crimped wires may be faulty Pinched, broken, or disconnected wiring Main board faulty.</p>	<p>Inspect crimp on CE3325 to ensure good connection Check connections from counters to main board. Check continuity on wires.(AACO3325, AACE7416)</p> <p>Replace main board. (AANEWGEN1-RBN)</p>
Menu Buttons do not work.	<p>Swap connectors at the 2 buttons Pinched, broken, or disconnected wiring Main board faulty.</p>	<p>Replace button if problem stays with button.(AAPB2700)</p> <p>Inspect crimp to ensure good connection. Check connections from menu buttons to main board. Check continuity on AAPB2700, AACE7416</p> <p>Replace main board. (AANEWGEN1-RBN)</p>

HOW TO:

How to: Access Display, Spotlights, and Actuator

- 1.) Remove the 3 bolts
- 2.) Remove the red bracket
- 3.) Flip display downward to access area.



How to: Access rear display time/score display.

- 1.) From the back of the game, remove the 4 #2 square screws and remove the wood panel.

Note: If the display is to be removed and replaced, it will have to be removed from the front.



How to: Change motor in the back of the game.

- 1.) Unplug game to remove power, remove back panel of game.
- 2.) Remove housing around motor.
- 3.) Remove snap ring and remove encoder wheel, sprocket, and chain.
- 4.) Unbolt motor.

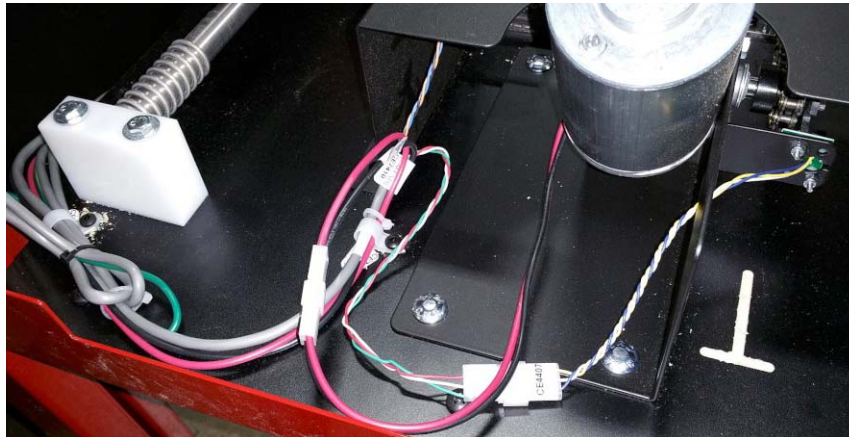

How to: Change Idler sprocket:

- 1.) Detach chain drive by removing 3 Phillips bolts
- 2.) Remove 6 Phillips bolts and remove the large bottom plate of sled.
- 3.) Use 7/16" socket to remove idler sprocket. (AASP7403)



HOW TO: UPDATE SOFTWARE

Needed for Software Update:

One USB stick for Newgen board

Installation Instructions:

Overview – This software upgrade consists of loading the software onto the NewGen Board.

NOTE: Game power must remain ON for this procedure.

1) Locate the USB stick with the MG designator for NewGen Board.

2) Access the Newgen main board on bottom front of game.

3) Insert the USB stick into the main board controller as shown here:

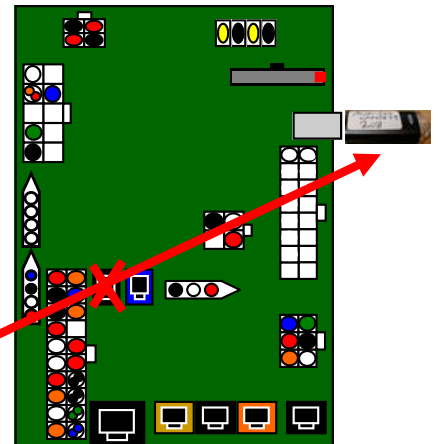

4) To trigger your file to load, press the small pushbutton next to the dipswitches.

NOTE: The file will load quickly; you will notice that the USB stick will flash, audio will reset after about 1 second, and the game will return to normal operating condition.

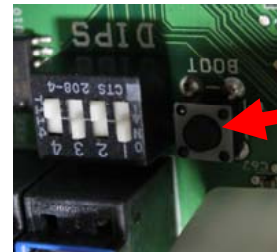

If you have any questions or need further assistance please contact Bay Tek Games. You may reach our Service Team at 920-822-3951 ext. 1102

BILL ACCEPTOR DIAGNOSTICS

Note: There are many different models and brands of Bill Acceptors that are used on redemption games. Your Bill Acceptor may differ from the unit shown.
Standard DBA is MEI # AE2451-U5E Part # A5AC9091

Determine if Bill Acceptor has power:

Turn game ON—The bill acceptor should make noise as stacker cycles and green lights on outside bezel should flash.

If NO power:

Use meter to measure 110 AC voltage at cable going into Bill Acceptor from power strip.

If power is OK:

Clean Bill Acceptor path to make sure there is nothing jamming unit.

Check dipswitch settings on side of acceptor.

Make sure switch # 8 is OFF for Always Enable

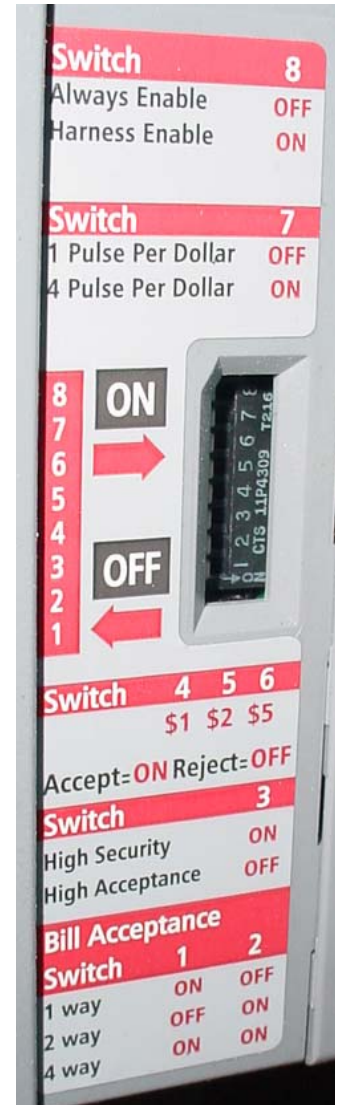
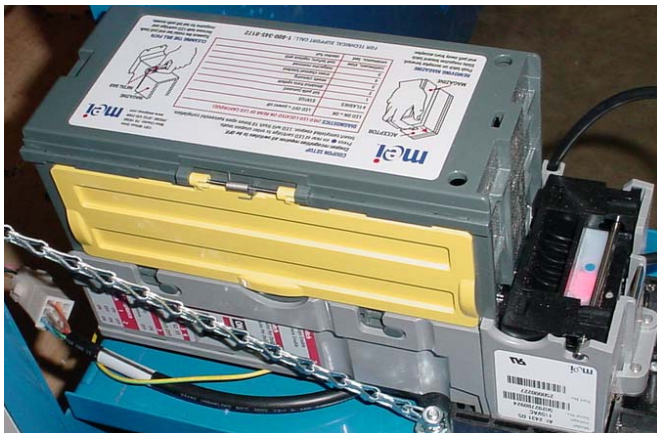

ERROR CODES

Count the number of flashes on front bezel of Bill Acceptor and follow chart for repair.

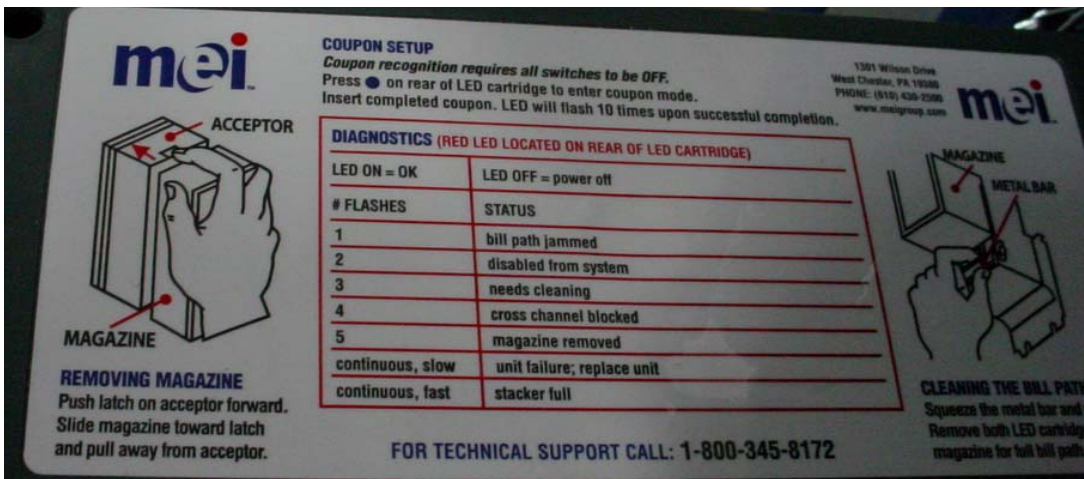

POWER SUPPLY DIAGNOSTICS

1.) Verify AC power to front of game. Check power strip in bottom front.
Check for illuminated power switch.

2.) Check AC power connection to power supply.

3.) Ensure Power Supply switch is set to 115V (or 230V)
(Some model power supplies may not have this)

4.) Ensure Power switch is on.

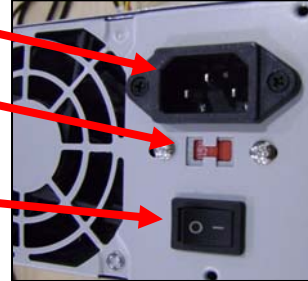

No 12 Volts (Power Supply Fan is not turning), but AC to power supply is OK

This means that either:

1.) Power supply is faulty.

2.) There is a 12 volt short in cabinet causing power supply to remain off to protect itself.

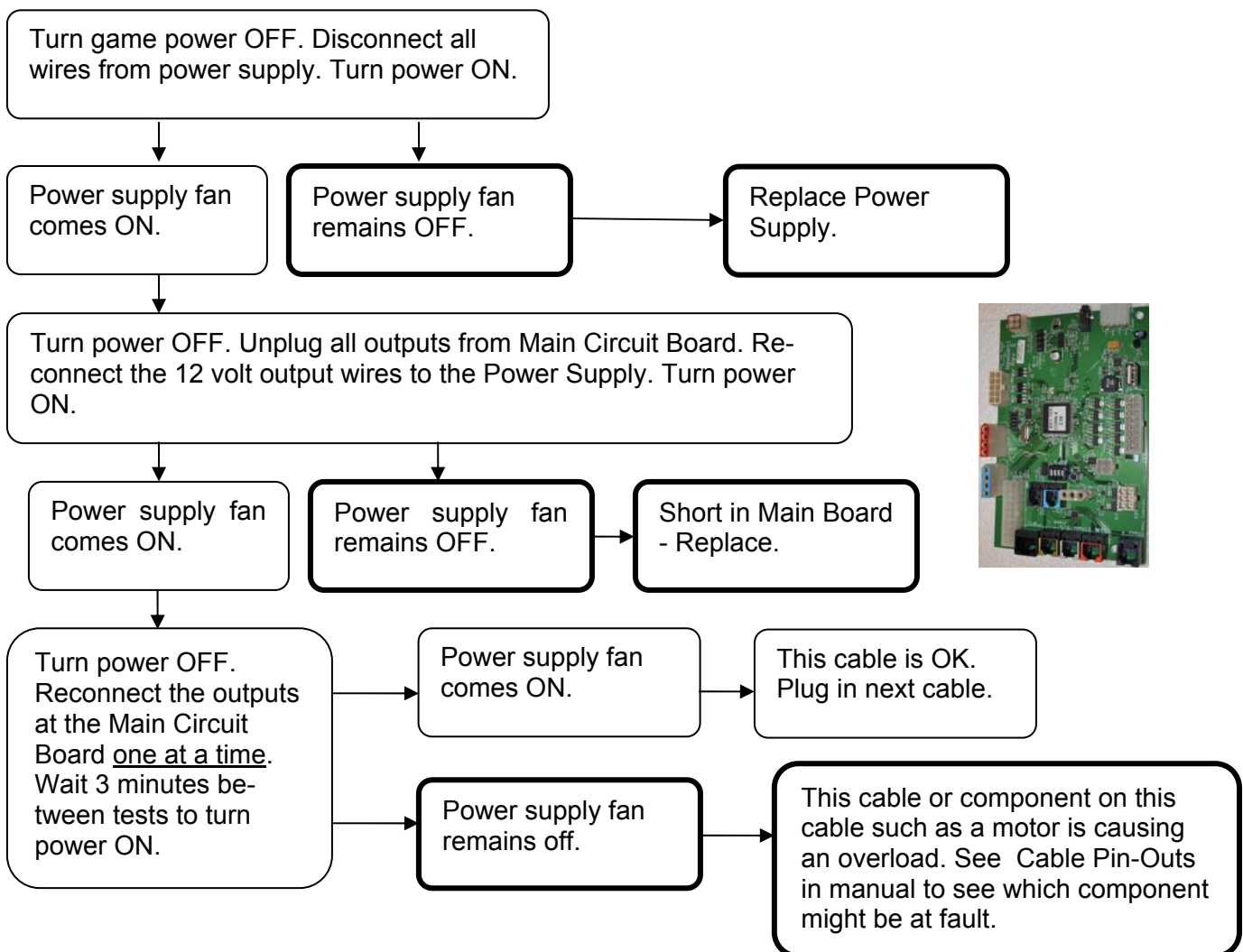

MAINBOARD PINOUT

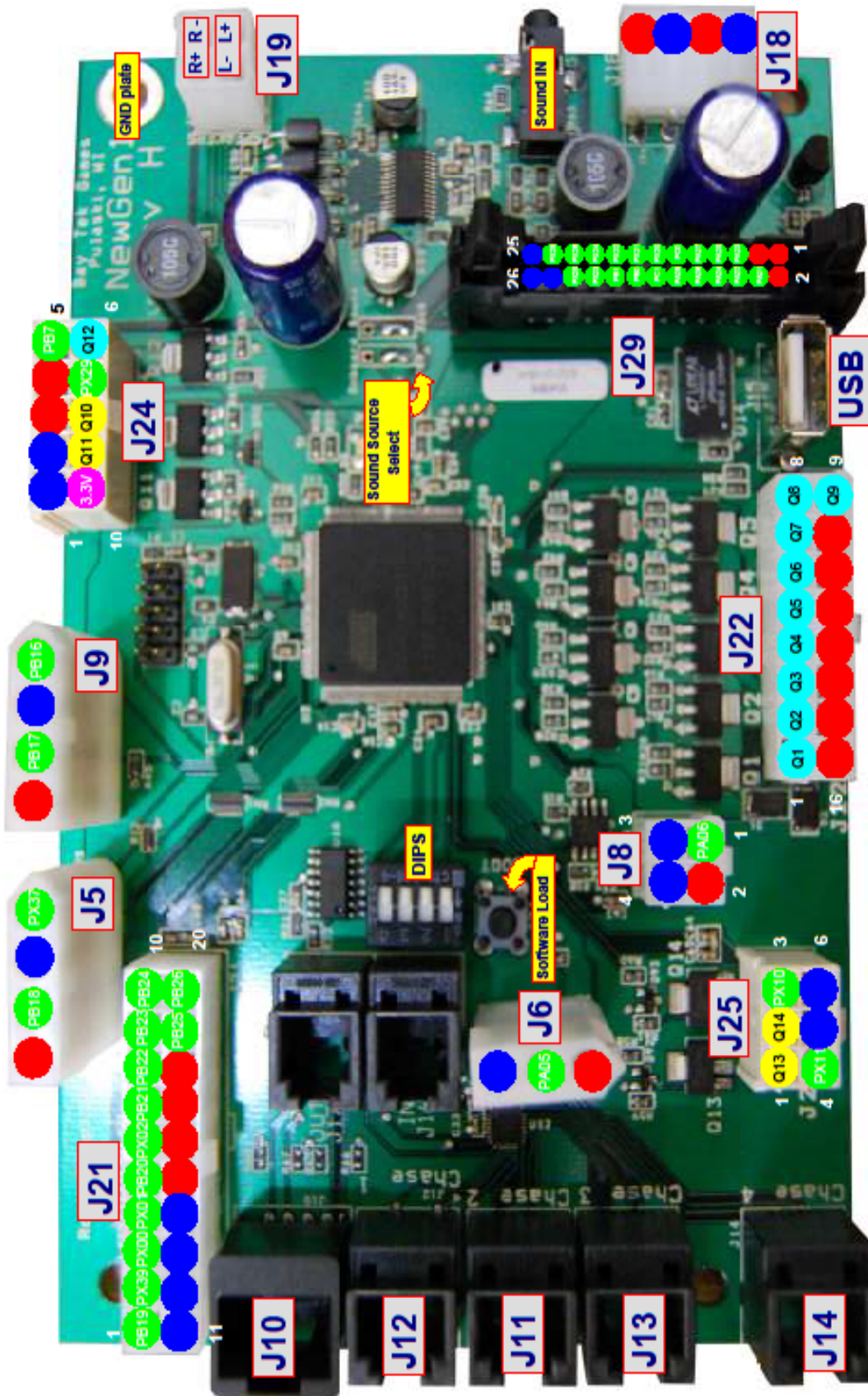

- SPI Out - Display - (J10)**
 - Pin 1 & Pin 3 - +12V
 - Pin 2 - SCLK_BUS2
 - Pin 4 - SMOSI_BUS2
 - Pin 5 & Pin 7 - Ground
 - Pin 6 - SCS2_BUS2
 - Pin 8 - SMISO_BUS2
- Chase Lights (J11,J12,J13,J14)**
 - Pin 1 - Chase Output
 - Pin 2 - Chase Output
 - Pin 3 - +12V
 - Pin 4 - Chase Output
 - Pin 5 - Chase Output
 - Pin 6 - +12V

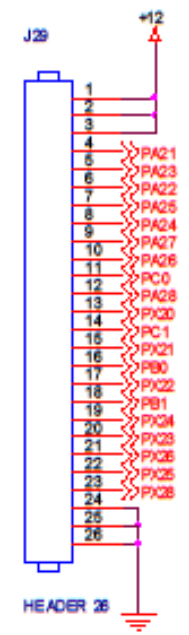

- Ground
- +12V
- Low Side Driver
- High Side Driver
- TTL Logic
- +3.3V

MAINBOARD PINOUT GUIDE

Pin Type	Purpose	Ref	Pin #
LOWSIDE #1,w diode		J22	1
LOWSIDE #2, w diode		J22	2
LOWSIDE #3		J22	3
LOWSIDE #4		J22	4
LOWSIDE #5		J22	5
LOWSIDE #6		J22	6
LOWSIDE #7		J22	7
LOWSIDE #8		J22	8
LOWSIDE #9		J22	9
+12 Volts		J22	11
+12 Volts		J22	12
+12 Volts		J22	13
+12 Volts		J22	14
+12 Volts		J22	15
+12 Volts		J22	16
PB16		J9	1
Ground		J9	2
PB17		J9	3
+12 Volts		J9	4
PA06	DBA Input	J8	1
+12 Volts		J8	2
Ground		J8	3
Ground		J8	4
+12 Volts		J29	1
+12 Volts		J29	2
+12 Volts		J29	3
PA21		J29	4
PA23		J29	5
PA22		J29	6
PA25		J29	7
PA24		J29	8
PA27		J29	9
PA26		J29	10
PC0		J29	11
PA28		J29	12
PX20		J29	13
PC1		J29	14
PX21		J29	15
PB0		J29	16
PX22		J29	17
PB1		J29	18
PX24		J29	19
PX23		J29	20
PX26		J29	21
PX25		J29	22
PX28		J29	23
Ground		J29	24
Ground		J29	25
Ground		J29	26

Pin Type	Purpose	Ref	Pin #
=Low Side Driver			
=High Side Driver			
= TTL Input/Output			
= LED Constant Current Drive			
= 12 Volts			
= Ground			
Ground		J24	1
Ground		J24	2
+12 Volts		J24	3
+12 Volts		J24	4
PB7	Hoop Sensor 1 Input	J24	5
LOWSIDE #12	Backboard Blinky Lights	J24	6
PX29	Hoop Sensor 2 Input	J24	7
HIGHSIDE #10		J24	8
HIGHSIDE #11		J24	9
3.3V		J24	10
PX37	Ticket Notch #1	J5	1
Ground	Ground for Ticket Dispenser	J5	2
PB18	Ticket Motor #1	J5	3
+12 Volts	Power for Ticket Dispenser	J5	4
HIGHSIDE #13	Games Counter	J25	1
HIGHSIDE #14	Tickets Counter	J25	2
PX10	Menu Button 1	J25	3
PX11	Menu Button 2	J25	4
Ground		J25	5
Ground		J25	6
+12 Volts	Coin Door Power	J6	1
PA05	Coin Input	J6	2
Ground	Coin Ground	J6	3
PB19	A Button Input	J21	1
PX39	B Button Input	J21	2
PX00	C Button Input	J21	3
PX01	Low Ticket Switch Input	J21	4
PB20	D Button Input	J21	5
PX02		J21	6
PB21	To Motor Driver IN1	J21	7
PB22	To Motor Driver IN2	J21	8
PB23	To Ball Gate Driver IN1	J21	9
PB24	To Ball Gate Driver IN2	J21	10
Ground		J21	11
Ground		J21	12
Ground		J21	13
Ground		J21	14
+12 Volts		J21	15
+12 Volts		J21	16
+12 Volts		J21	17
+12 Volts		J21	18
PB25		J21	19
PB26	NJ Lockout	J21	20

PARTS LIST

A5BA8300	8.5" Basketball	A5ME7466	Metal Right Hand BB Mount Bracket
A5ME7461	14" Rim	A5CORD29	25' SJT Cord
A5NE2601	Net for Rim	AACE4401	LED Cable, Ball Area
A5CB2050	Cash Box	AACE7400	Front Display Power Cable
A5F19010	Inline Filter	AACE7401	DBA Cable
AASW200	Low Ticket Switch	AACE7402	Rear Display Jumper Cable
AACO3325	Counter (No Feet)	AACE7403	Front Hoop Sensor Cable
AA2W500	Reflective Tape (1" Section)	AACE7404	Door Cable
A5PB8300	Push Button, Basketball Logo	AACE7405	Speaker Cable
A5LK2001	Cash Box Lock & Key A05/E00	AACE7406	Driver Board Power Cable
A5LK5002	H95 Lock & Key	AACE7407	Back Light Cable
A5SW7000	Back Door Interlock Switch	AACE7408	New Gen1 to Display Jumper Cable
A5BKS001	Bracket for Interlock Switch	AACE7409	Front Display Jumper Cable
AABK1013	Push Button/Counter Bracket	AACE7410	Back Motor Power Cable
A5PL9097	Blanking Plate	AACE7411	Front Door Ground Cable
A5CH1015	Chain #35 153 Links, 2 Master Links	AACE7412	Back Ground Wire
A5LE8300	Adjustable Leveler	AACE7414	Front Ground Wire
A5SP7402	Compression Spring	AACE7415	Front Display Cable
A5PL8600	Round Plastic Plug (1 3/8" Dia)	AACE7416	Counter/Menu Buttons Jumper Cable
A5BR8300	Black Trolley Bearing	AACE7419	Back Display Cable
A5SH8300	3/4" Center Support Shaft	AACE7422	Front Home Cable
A5SH8301	3/4" End Support Shaft	AACE7423	Front Motor Power Cable
A5SH8302	Shaft Trolley Guide	AACE7424	Front Light Cable
AASP7403	Sprocket, Idler Arm With Bushing	AACE7425	Rear Display Jumper Cable
A5BESV003	Bushing for Idler Arm Sprocket	AACE7426	Rear Home & Encoder Sensor
A5BK9999	Power Supply Bracket	AACE7427	Rear Hoop Sensor
W5HG1065	Single Bend Hinge	AACE7428	Ground Wire
A5ME2035	Metal Ticket Tray	AACE7429	Back Display Jumper Cable, 5V
A5ME7405	Metal Outside Console Panel	AACE7430	Ribbon Cable for Display
A5ME7406	Metal Inside Console Panel	AACE7431	Flood Light
A5ME7407	Metal Front Console Panel	AACE7432	Trolley Ground Cable
A5ME7408	Metal Rear Console Panel	AACE7433	Power Supply AC Jumper Cable
A5ME7409	Metal Front Ramp Console	AACE9407	Outlet Strip Cable
A5ME7410	Metal Rear Ramo Console Bracket	AACE9413	New Gen1 Power Cable
A5ME7411	Metal Panel Door	AACE9418	Display Jumper
A5ME7416	Metal Left Hand Front Post	AACE9419	Display Jumper
A5ME7417	Metal Right Hand Front Post	AACBL4A-DOORA	Door Cable
A5ME7418	Metal Front Top Leg Bracket	AACE8811	Speaker Assembly
A5ME7419	Metal Front Bottom Leg Bracket	AAPB2700	Push Button Assembly
A5ME7420	Metal Left Hand Post	A5TD1	Ticket Dispenser
A5ME7421	Metal Right Hand Post	A5PS6900	Power Supply for Motor Driver Board
A5ME7422	Metal Lower Rear Piece	AAMO7400	Motor
A5ME7423	Metal Lower Rear Cover	AAPS1013-SSHOT	Power Supply
A5ME7424	Metal Left Hand Side Cage Panel	AACE7421	Actuator Assembly With Extension
A5ME7425	Metal Right Hand Side Cage Panel	A5DE0042	New Menu/Volume Pot Decal
A5ME7426	Metal Top Scoreboard Bracket	A5DE7400	Display Scoreboard Plexi
A5ME7427	Metal Lower Scoreboard Bracket	A5DE7401-1	Deluxe Control Panel Plexi
A5ME7432	Metal Nut Guide Plate	A5DE7401-2	Standard Control Panel Plexi
A5ME7435	Metal Trolley Base	A5DE7402	Front Door Decal
A5ME7436	Metal Left Hand Trolley Panel	A5DE7403	Backboard Decal
A5ME7437	Metal Right Hand Trolley Panel	A5DE7404	Back Wall Decal
A5ME7438	Metal Backboard Support Panel	A5DE7405-1	Pinch Hazard Danger Decal
A5ME7439	Metal Backboard Mounting Bracket	A5DE7405-2	Notice Rail Cleaning Decal
A5ME7444	Metal Chain Mount Bracket	A5DE7405-3	Notice Backboard Connection Decal
A5ME7445	Metal Front Shield Bracket	A5LD1052	LED Modular Display
A5ME7446	Metal Idler Sprocket	AACE7418	Hoop Sensor
A5ME7449	Left Side Console Weldment	AACB3906	Actuator Driver Board
A5ME7450	Right Side Console Weldment	A5CB9507	Motor Driver Board
A5ME7451	Floor Console Weldment	AACB3904	Ribbon Splitter/DOT Matrix Board
A5ME7452	Light Housing Weldment	AACB4401	Encoder Sensor W Cable
A5ME7453	Ball Stop Weldment	AACB4403	Reflective Sensor
A5ME7454	Side Cage Weldment	AANEWGEN1-RBN	New Gen1 Main Board
A5ME7455	Top Cage Weldment		
A5ME7456	Metal Display Holder Bracket		
A5ME7462	Metal Motor Bracket		
A5ME7463	Metal Bottom Motor Bracket		
A5ME7464	Metal Motor Cover		
A5ME7465	Metal Left Hand BB Mount Bracket		

PARTS PICTURES

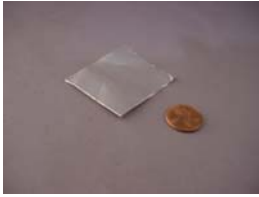

AASW500



A5BA8300



A5CB2050



A5CH1007



A5DE0042



A5DE8716



A5FI9010



A5LK2001



A5LK5002



A5PB8300

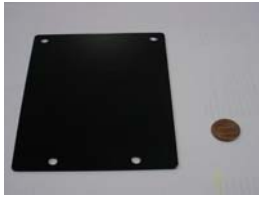

A5PL9097



AABK1013



A5CORD5



AACBL4A-DOOR



AACE7400



AACE7401



AACE7402



AACE7403



AACE7404



AACE7405



AACE7406



AACE7407

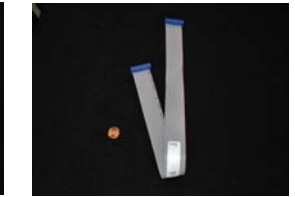

AACE7408



AACE7409



AACE7410



AACE7411

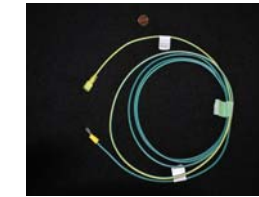

AACE7412



AACE7413

PARTS PICTURES CONT.



AACE7414



AACE7415



AACE7418

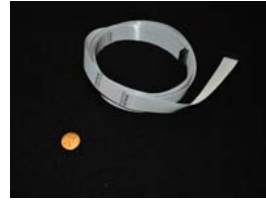

AACE7419



AACE7421



AACE7422



AACE7423



AACE7424



AACE7425



AACE7426



AACE4327



AACE7428



AACE7429



AACE7431



AACE7433



AACE8811



AACE9407



AACE9413



AACE9418



AACE9519



AANEWGEN1-RBN



AAPB2700



AAPS1013-SSHOT

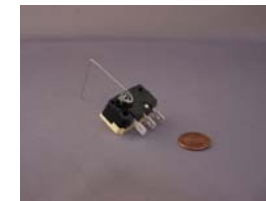

AASW200



A5TD1



AACB4403



AACB3904



AACB3906



AACB4401

OPTIONAL JACKPOT SIGN WIRING DIAGRAM

**** JACKPOT SIGN IS AN OPTIONAL ADD-ON FEATURE, NOT STANDARD**

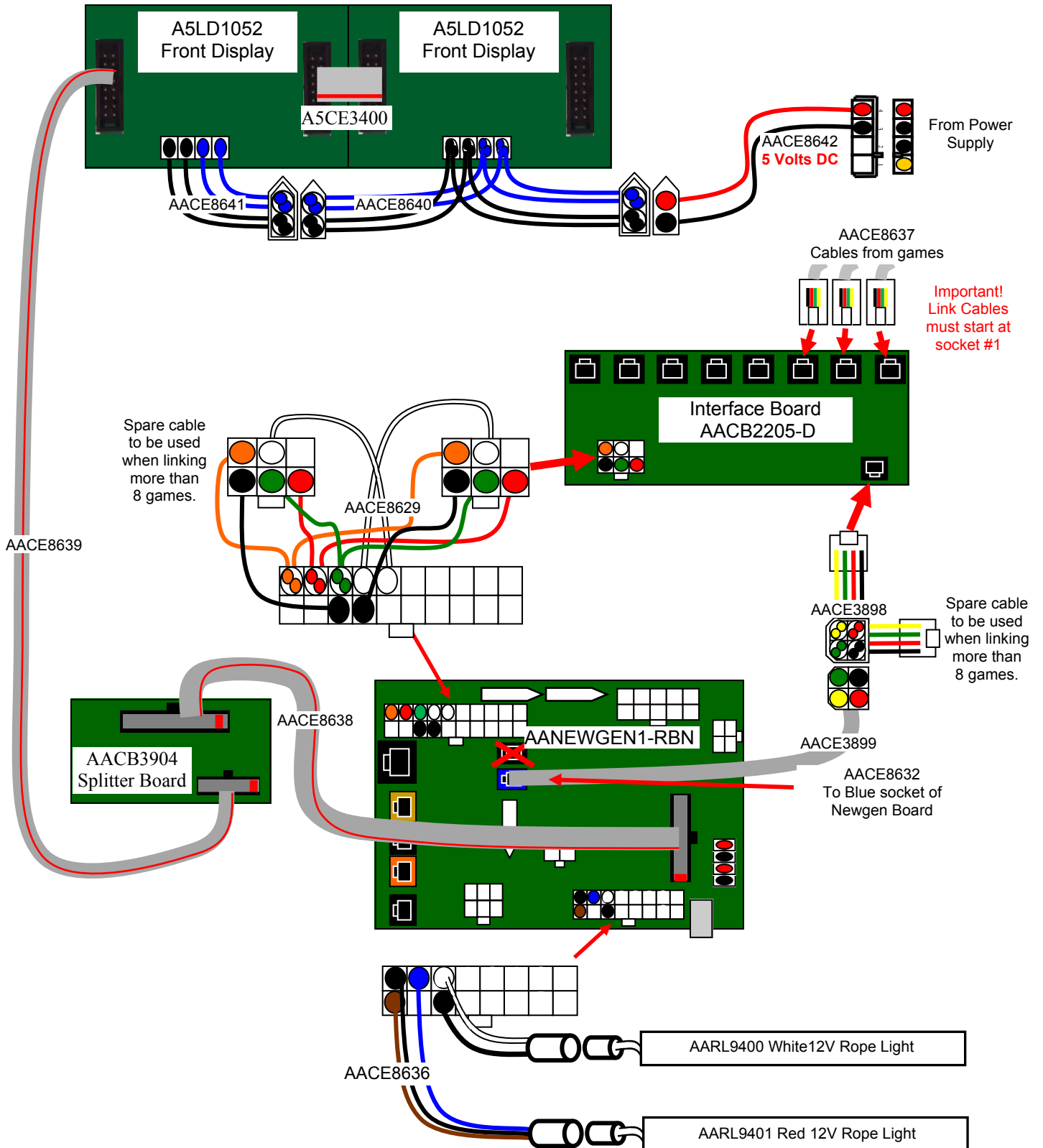

JACKPOT SIGN WIRING DIAGRAM & PIN OUT

****JACKPOT SIGN IS AN OPTIONAL ADD-ON FEATURE, NOT STANDARD**

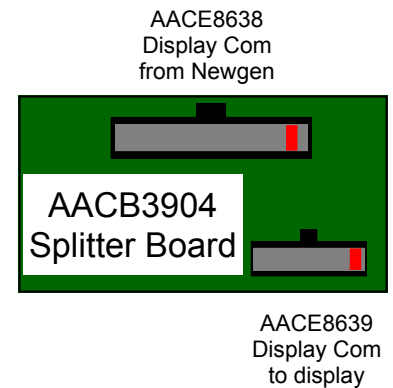
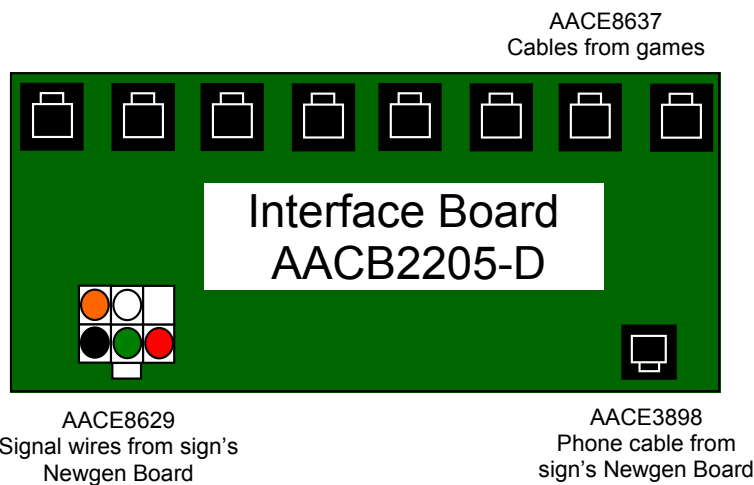
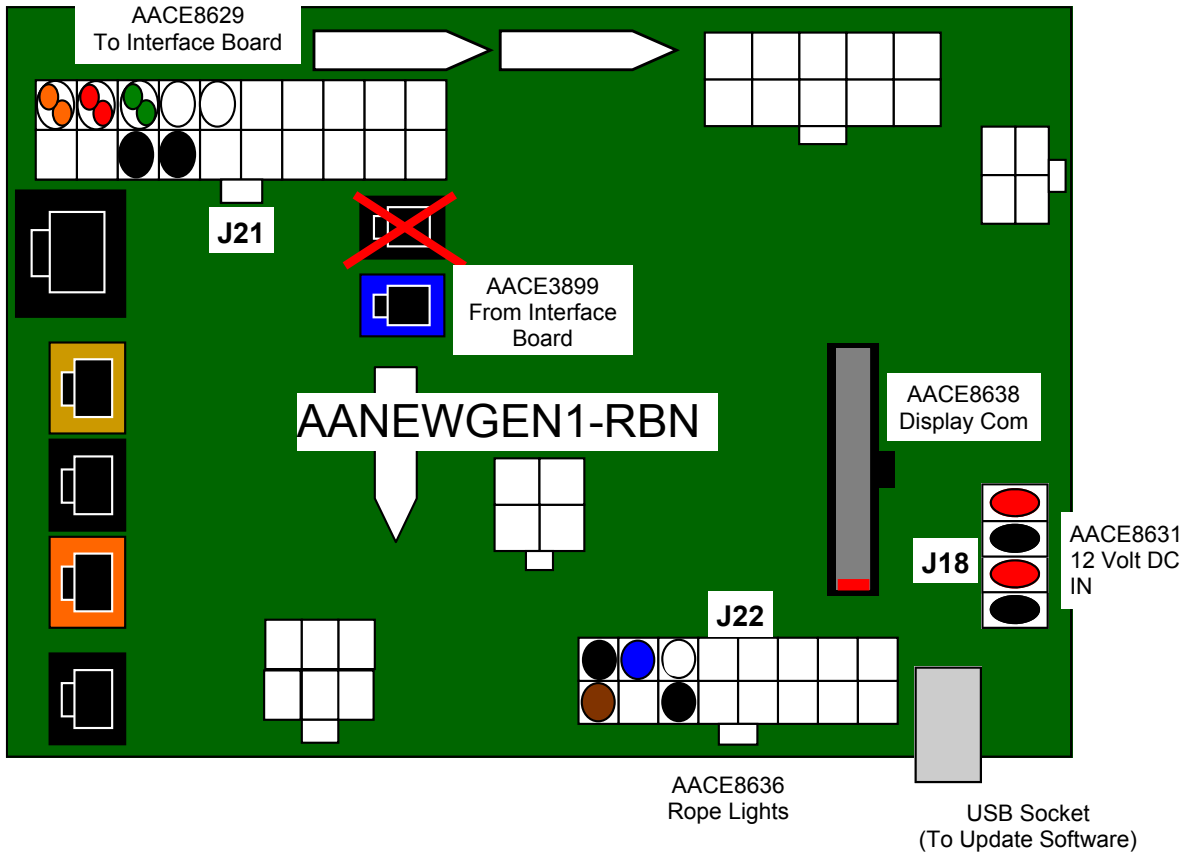

JACKPOT SIGN POWER WIRING DIAGRAM

****JACKPOT SIGN IS AN OPTIONAL ADD-ON FEATURE, NOT STANDARD**

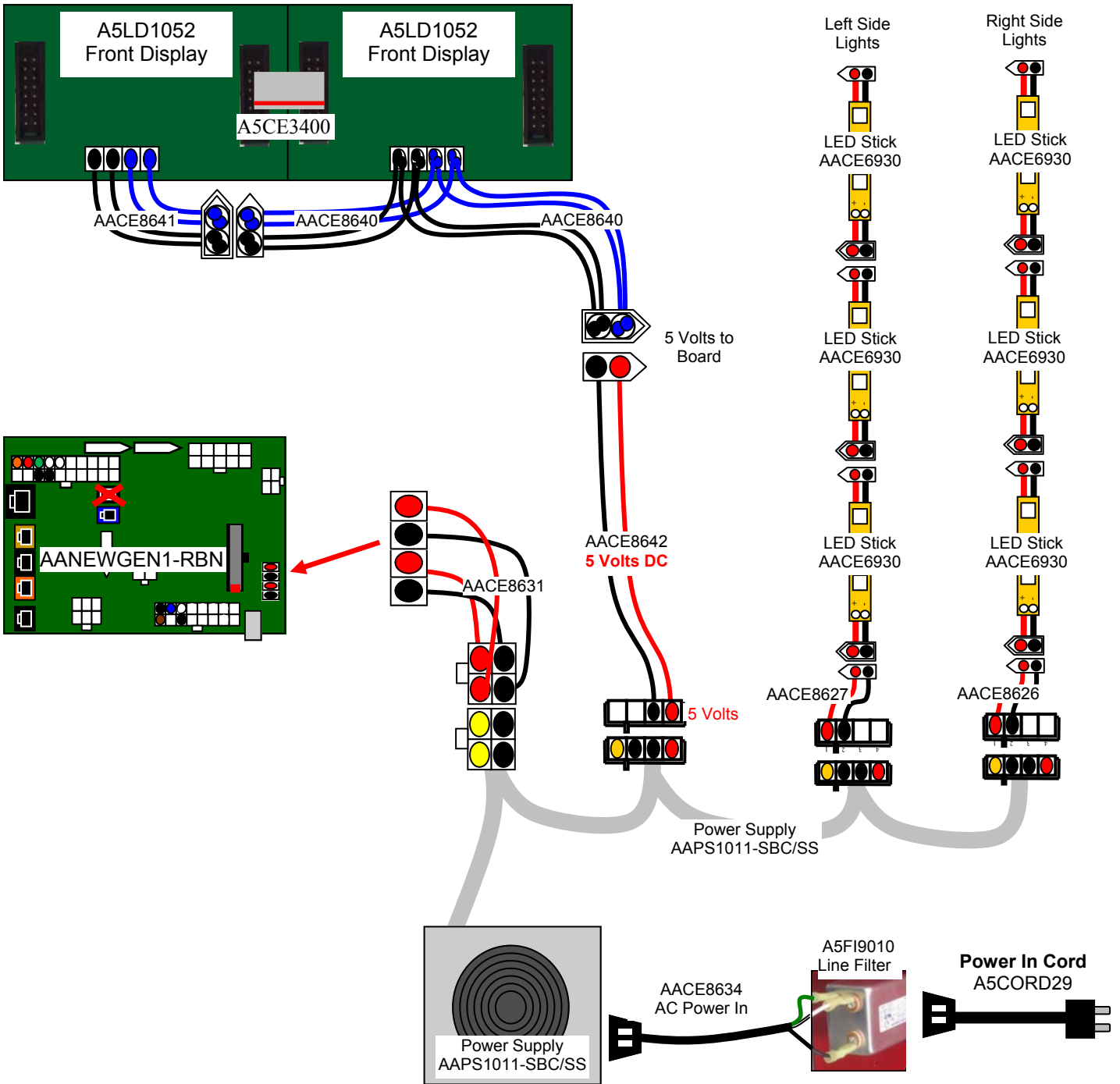

JACKPOT SIGN TROUBLE SHOOTING GUIDE

****JACKPOT SIGN IS AN OPTIONAL ADD-ON FEATURE, NOT STANDARD**

Problem	Probable Cause	Remedy
No power to the sign.	Unplugged. Circuit breaker tripped Bad power supply.	Check wall outlet to line filter in back of sign. (A5F19010) Reset power strip breaker switch or building circuit breaker. Fan on Power Supply should be turning. If not - check rocker switch on power supply. Replace Power Supply (AAPS1011-SBC/SS) If fan is turning on Power Supply, check cables that come from the Power Supply to the rest of the sign.
Chase lights on sign do not flash.	LED strip faulty Faulty Cable Faulty NewGen Board	The 12 volt white LED rope light should be on all the time. The 12 volt red LED rope light will flash all the time. Check cables from LED strips to NewGen Board.(ACE8636) Replace NewGen Board. (AANEWGEN1-RBN)
LED's lighting up left & right sides not working. LED's should be ON all the time.	Faulty cable wire or connection Faulty LED light strip.	Check for proper connection from LED's to power supply. Check continuity. (ACE6930, ACE8626, ACE8627, AAPS1011-SBC/SS) Replace LED light strip. (ACE6930)
Display Boards not working	No 5 Volts to Display Faulty Ribbon Cable Display Board faulty	Check power supply connector and ensure 5 volts is going to display board. Cable #'s: ACE8642, ACE8641, ACE8641 Check for proper connection from NewGen Board to Display. Reset cables. Check continuity. (ACE8638, ACE8639) Swap the 2nd board into the 1st location to determine if display board is faulty. Replace if needed. (A5LD1052)
Game is not incrementing sign. (No communication from games)	Faulty cable wire or connection Faulty Board.	Check for proper connection from ACE8637 cable from game to the sign. Up to 8 games can be plugged into AACB2205-D board. Swap this cable from one game to the next to verify game issue Check ACE8629 cable to AACB2205-D board. Check ACE3898 and ACE3890 phone cable from Newgen to AACB2205-D board Replace AACB2205-D board or AANEWGEN1-RBN board.

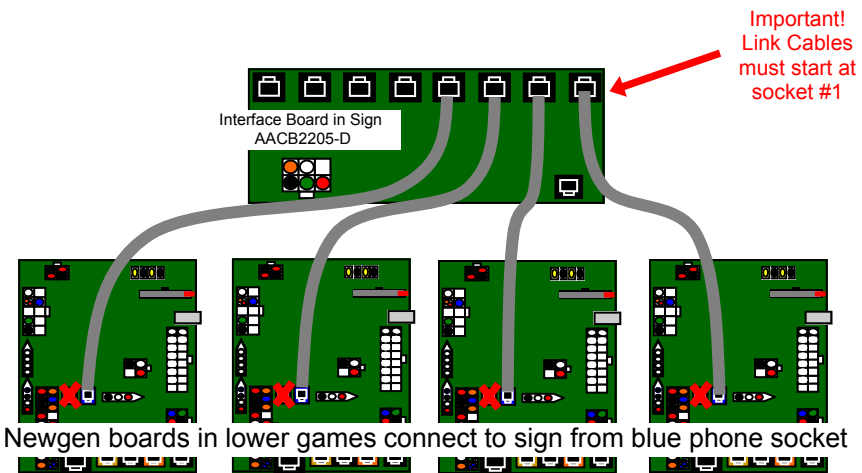

OPTIONAL GAME DIVIDER INSTALL INSTRUCTIONS

****GAME DIVIDERS ARE AN OPTIONAL ADD-ON FEATURE, NOT STANDARD**

TOOLS REQUIRED:

DRILL

#3 PHILLIPS BIT

7/16" SOCKET OR WRENCH

Set up all games in the bank as instructed in the game manual. Installing the dividers will be the last steps to complete the bank of games.

Separate the games in the bank, creating space where the dividers will be placed.



Remove the four screws from the back of the games (2 per game), located near the floor, where the dividers will be installed.



Install the bar piece between the two games with the SLOTS FACING UP! Secure the bar to the games using the same screws you removed in the previous step. Start all four screws first, then tighten once threaded in.

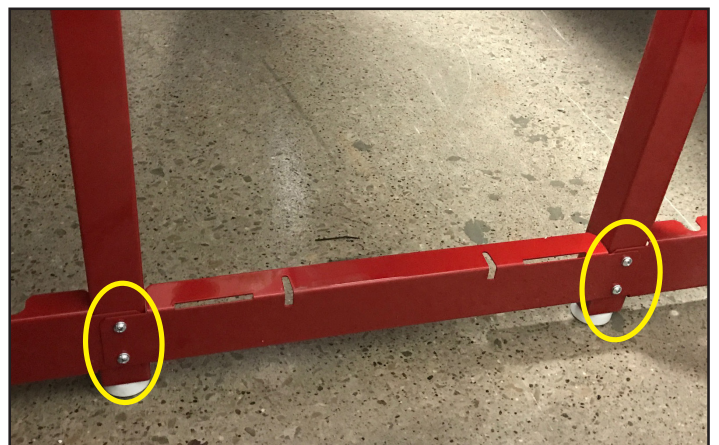

OPTIONAL GAME DIVIDER INSTALL INSTRUCTIONS

****GAME DIVIDERS ARE AN OPTIONAL ADD-ON FEATURE, NOT STANDARD**

In the front of the games, remove the four screws from where the ramps and the consoles are secured together - 2 screws per unit.

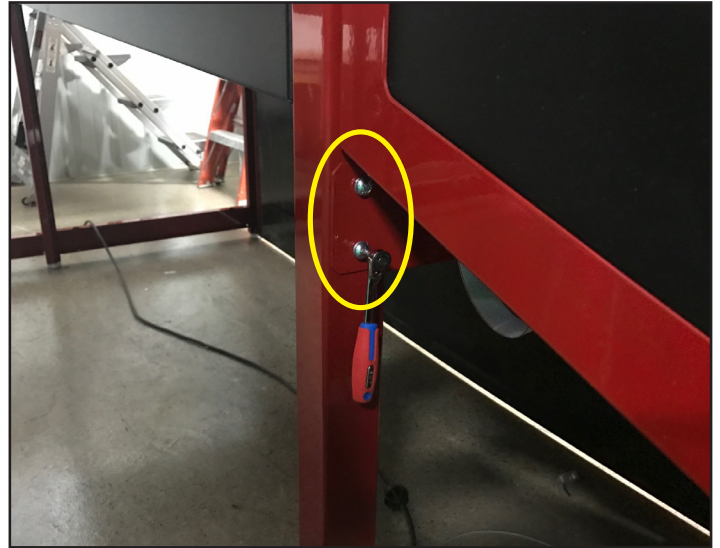

Install the bar piece between the two games with the SLOTS FACING UP! Secure the bar to the games using the same screws you removed in the previous step. Start all four screws first, then tighten once threaded in.

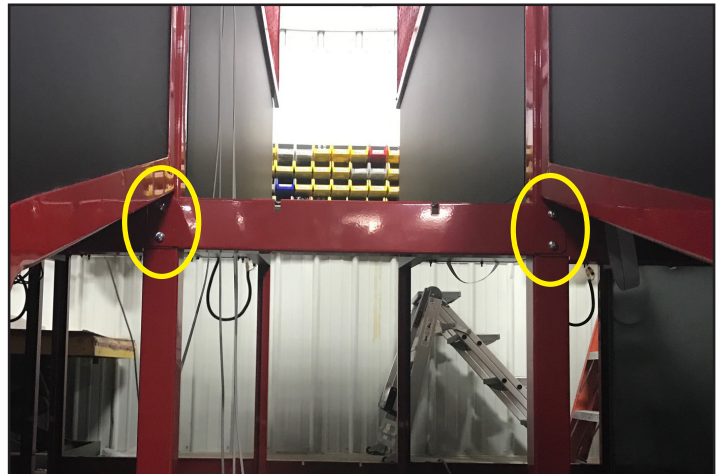

Remove the four screws that secure the cage pieces to the ramp pieces - 2 screws per unit.



OPTIONAL GAME DIVIDER INSTALL INSTRUCTIONS

****GAME DIVIDERS ARE AN OPTIONAL ADD-ON FEATURE, NOT STANDARD**

Carefully install the vertical divider piece between the two games - be careful not to scratch any pieces!



Be sure to push the divider piece as far back towards the rear of the game as it will go. This is critical to make sure the table divider piece will fit in as needed.

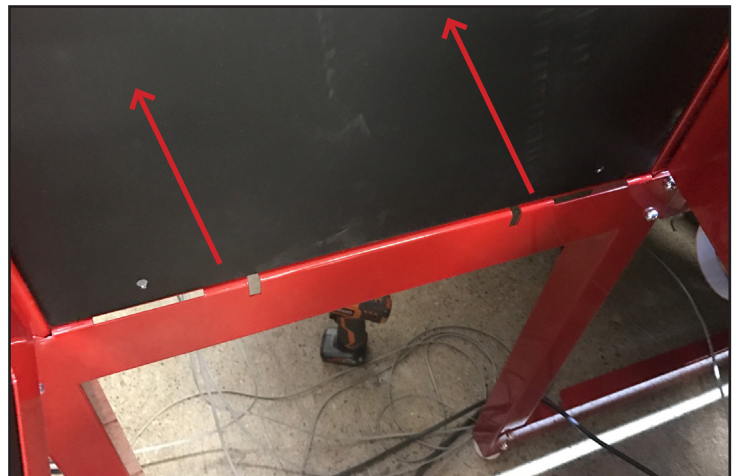

OPTIONAL GAME DIVIDER INSTALL INSTRUCTIONS

****GAME DIVIDERS ARE AN OPTIONAL ADD-ON FEATURE, NOT STANDARD**

From the hardware kit, use 2 flat washers and 2 nylon nuts to secure the divider to the pem studs on the bottom inside of the piece.

Use 2 lock washers and 2 short screws to secure the sides of the divider to each unit.

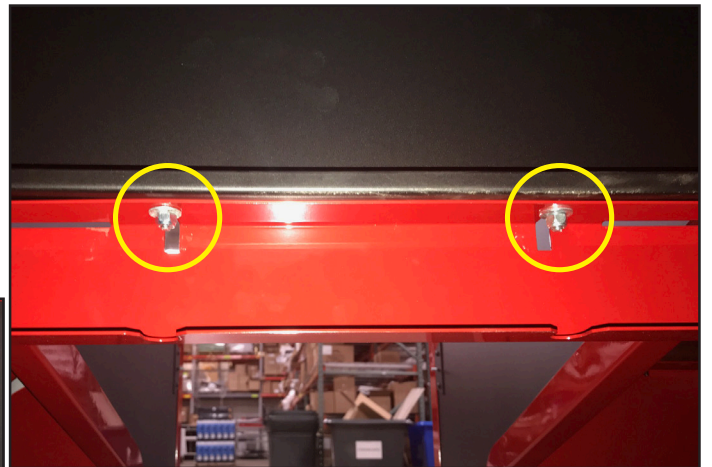
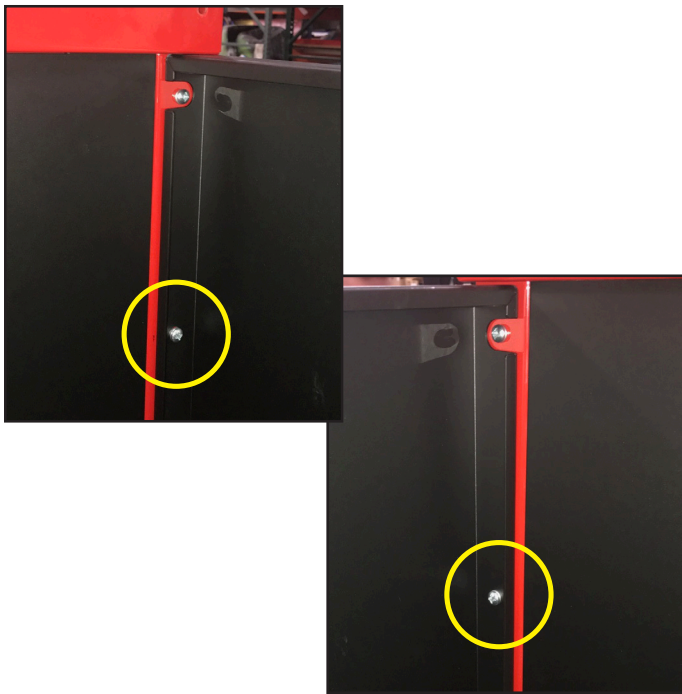
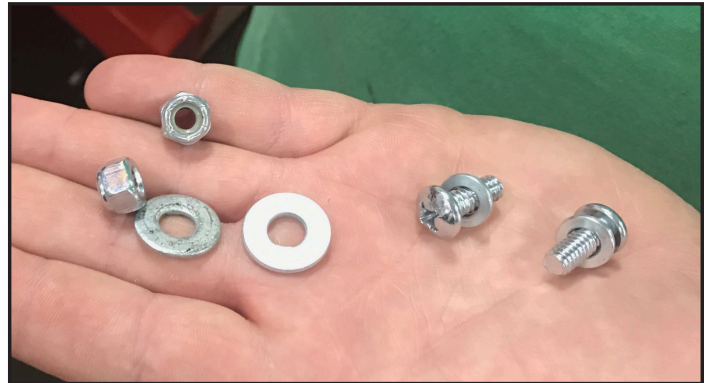

Reinstall the bottom screws you removed earlier, leaving the top holes open.



OPTIONAL GAME DIVIDER INSTALL INSTRUCTIONS

****GAME DIVIDERS ARE AN OPTIONAL ADD-ON FEATURE, NOT STANDARD**

With assistance, carefully install the cage divider piece between the two games - be careful not to scratch any pieces!



Once installed, secure the cage divider to the cage pieces on each side using the longer, 1-1/4" screws and nylon nuts from the hardware kit.

The top screws will get inserted from "outside" the cage divider to the inside.

The bottom screws will get inserted from "inside" the cage divider to the outside.



OPTIONAL GAME DIVIDER INSTALL INSTRUCTIONS

****GAME DIVIDERS ARE AN OPTIONAL ADD-ON FEATURE, NOT STANDARD**

Carefully install the “table divider” with the cup holders between the two games - be careful not to scratch any pieces!



Secure the table divider to each game using a flat washer and a nylon nut from the hardware kit, on each side.



Remove the two self-tapping screws from each game side equaling 4 total.



OPTIONAL GAME DIVIDER INSTALL INSTRUCTIONS

****GAME DIVIDERS ARE AN OPTIONAL ADD-ON FEATURE, NOT STANDARD**

Remove the self-tapping screw from the under side, center of the table divider.



Carefully install the divider art acrylic piece between the two games.



Behind the divider art piece, secure it to the games using the five self-tapping screws you removed earlier.



OPTIONAL GAME DIVIDER INSTALL INSTRUCTIONS

****GAME DIVIDERS ARE AN OPTIONAL ADD-ON FEATURE, NOT STANDARD**

Repeat this process as many times as needed to install the dividers where needed.



OPTIONAL SIDE SKIRT INSTALL INSTRUCTIONS

****SIDE SKIRTS ARE AN OPTIONAL ADD-ON FEATURE, NOT STANDARD**

Gather the hardware kit with the two black self tapping screws in it - this will be found inside the cash box.



The side skirt piece will be located inside the ball return ramp. Remove the piece.



Under the ball return ramp, you will need to remove two silver screws on the side you are going to install the side skirt on. Set the screws to the side for now, you will need to reinstall them shortly.



OPTIONAL SIDE SKIRT INSTALL INSTRUCTIONS

****SIDE SKIRTS ARE AN OPTIONAL ADD-ON FEATURE, NOT STANDARD**

From under the ball return ramp, slide the skirt piece into position and secure in place using the silver screws you earlier removed.

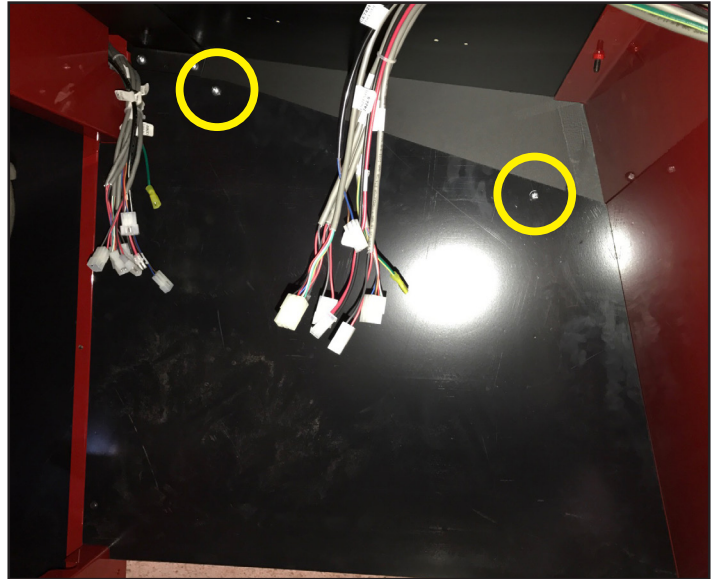

Use the two black self tapping screws and secure the back of the skirt to the front of the ramp.

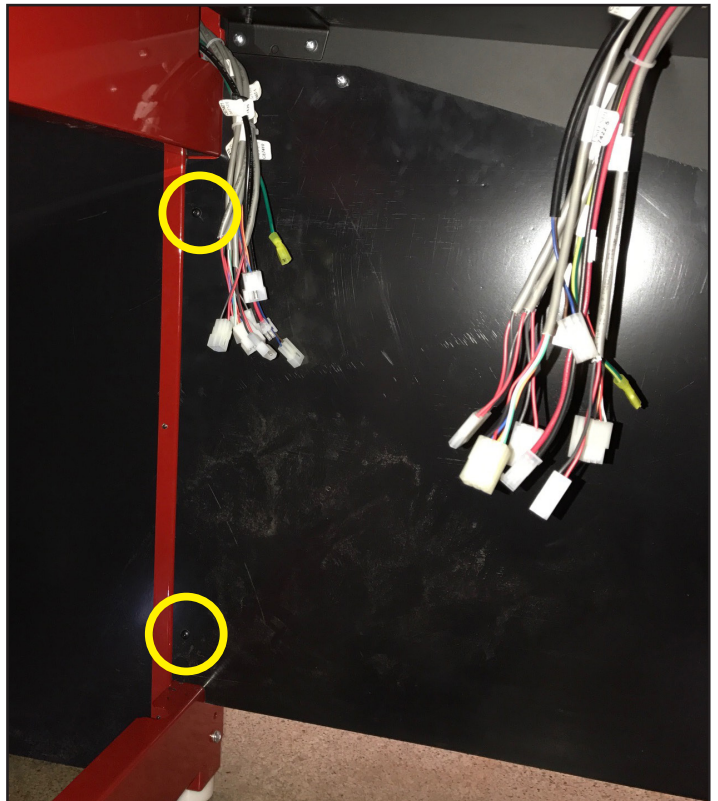

The install process will be the same for either left or right side of the game. Repeat as needed.

TECHNICAL SUPPORT

Excellent customer service is very important to Bay Tek Games!

We know that keeping your games in great operating condition is important to your business. When you need us, we are here to help. You can call us for free technical assistance, and you can count on us to have parts on-hand to support your game. We offer options that fit your needs.

Electronics / Circuit Boards - Repair Options

Repair & Return – If you have Circuit Board issues with your Bay Tek game, you can send the board to us and we'll repair it right away. Most items sent to us are repaired and returned to you within two days. This option is your best value as we offer this fast turn-around service at the most reasonable price.

Advance Replacement – If you have Circuit Board issues with your Bay Tek game, but you don't have time to send in your board in for repair, give us a call and ask for an Advance Replacement. We'll send you a replacement board that same day (pending availability). When you get your new board, just repackage the defective board in the same box and send it back to us. We make it easy by including a UPS Return Shipping label for you to put on the box (not available for international shipments). This is your best option when you need to get your game up and running as quickly as possible!

Spare Parts – Take matters into your own hands and purchase new spare Circuit Boards for your Bay Tek games. Many of our games share the same main-board electronics. This means you can buy one set of spare electronics to support many of your Bay Tek games. Spare boards allow you to get your game up and running the quickest and provide you a valuable troubleshooting option. Call our technicians to get recommendations for what you should keep on hand for spare parts!

Technical Support:

“You” are the best tool for troubleshooting! Your abilities to understand the game and your skills to repair the game are invaluable to us! If you need help, you know you can call us. It's not easy to diagnose a game remotely by phone, but our technicians do a great job. They'll need your help to perform some troubleshooting steps and convey to them exactly what's happening with your game.

Returns, Credits, & Fees:

NOTICE! ALL ITEMS being sent to Bay Tek Games for repair or return, etc. require prior Return Authorization! Bay Tek Games will provide a Product Return Form with an authorizing Ticket Number for each item to be returned. Please be certain to include this document with all shipments!

Late Fees and Non-Return Fees - Advance Replacement and Warranty Replacement items require the defective items to be returned by Bay Tek games promptly to avoid Late Fees. We expect items to be returned with 10 working days. Late fees are invoiced monthly. Late fees are non-refundable under any circumstance! Any item not returned within 90 days will be invoiced in full as a replacement part.

Bench Fees - Bench fees will apply for each electronic item returned to Bay Tek Games (this includes unused Advance Replacement items). This charge covers our cost to inspect, evaluate and retest each item. Please note that returned items that do not pass our tests will be charged accordingly as replacement items or advance replacements.

Restocking Fees - Unused items returned for credit will be credited minus a restocking fee. Items must be returned within 30 days of purchase in order to qualify for any credit amount. No shipping charges will be credited.

WARRANTY

Bay Tek Games warrants to the original purchaser that all game components will be free of defects in workmanship and materials for a period of 6 months from the date of purchase. If you fill out the registration card in the cashbox of the game, Bay Tek will add another 3 months to your warranty, free of charge.

Bay Tek Games will, without charge, repair or replace defective component parts upon notification to the parts/service department while the game is under warranty.

Warranty replacement parts will be shipped immediately, via ground service, along with a Product Return Form for the return of defective parts.

Defective parts must be shipped back to Bay Tek Games unless otherwise instructed. Items not returned to Bay Tek Games will be invoiced as replacement parts.

This warranty does not apply in the event of any misuse or abuse to the product, or as a result of any unauthorized repairs or alterations. The warranty does not apply if any serial number decal is altered, defaced, or removed from its original position.

 **ATTENTION** 

In order to maintain the safety & compliance certifications of this game, **ONLY** approved parts may be used. For approved replacement parts, refer to the parts list in this manual.

Should you need your game serviced, determine the serial number from the decal placed on the front of this manual, or locate it on the back of the game. Then contact our Service Department at: 920.822.3951 or e-mail: service@baytekgames.com

NON-WARRANTY

Options and estimated charges will be provided to you for your approval.

Please remember that any items being sent to Bay Tek Games must include prior return authorization from our Parts & Service Department.

This approval will include a Product Return Form which is required to be included with any incoming shipments. Repaired parts will be shipped back using the same method in which they were received.

Repairs are warranted for 30 days from the date of return shipment.